

User Guide

Meeting

Instant Meeting

Introduction

Once you have logged in to a Teams account with MeetingBar A10/A20/A30 (hereinafter referred to as MeetingBar AX0), you can invite people to start an instant meeting. After the meeting is successfully created, you can also [invite participants](#) to join the meeting.

You can enable or disable the camera/microphone in an instant meeting, but not other [participants'](#) camera/microphone.

Before You Start

You need to log in to your Microsoft Teams account in MeetingBar AX0.

Use via Remote Control

Select **Meet** to invite participants to join the meeting.

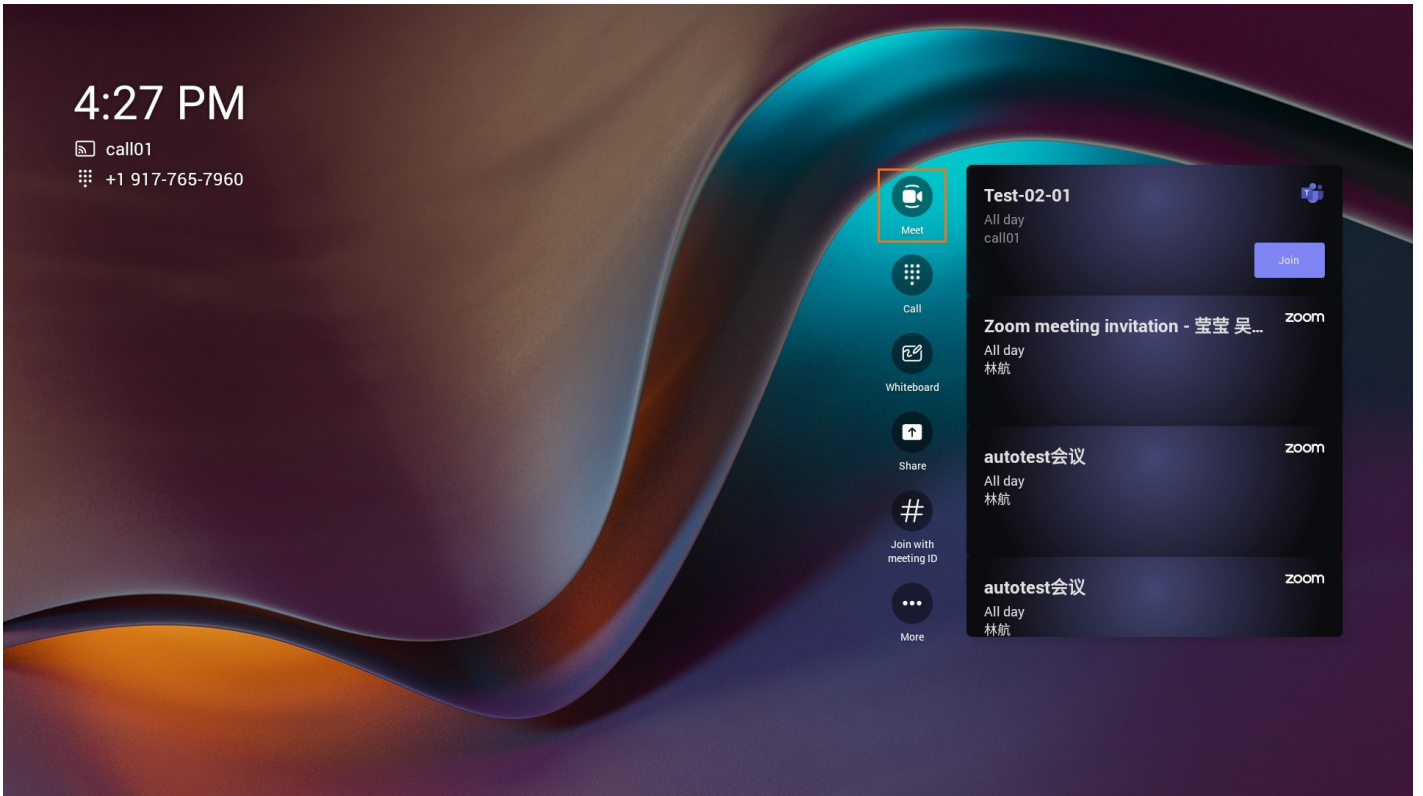

Use via CTP18 Control

Select **Meet** to invite participants to join the meeting.

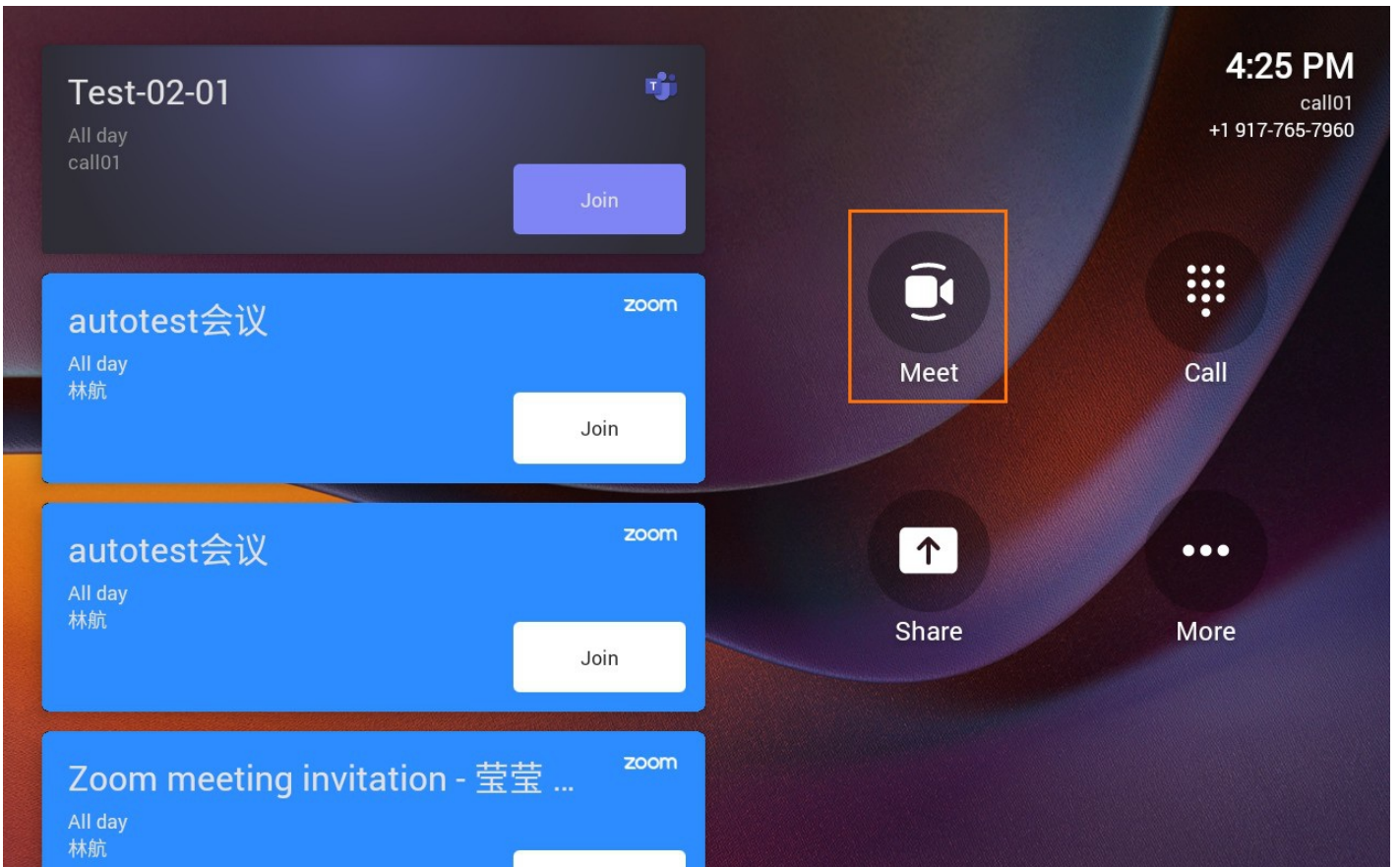

FAQ

Does it support reserving meetings on the MeetingBar AX0 or CTP18?

The MeetingBar AX0 cannot reserve a meeting directly, only on a Teams client that is logged in to the same account. After reserving the meeting, the information will be displayed on the display device connected to the CTP18 and MeetingBar AX0.

For more information, please refer to [Schedule a Meeting in the Teams PC Client](#) / [Schedule a Meeting in the Teams Mobile Client](#).

Join Meeting

Introduction

Join a scheduled meeting: If you have a MeetingBar A10/A20/A30 scheduled or invited meeting, the meeting schedule will be displayed on the device, and you can choose one meeting to join.

Join with Meeting ID: Enter the Teams MeetingBar A10/A20/A30 meeting ID and password to join the meeting.

Proximity Join: You can move a Teams MeetingBar A10/A20/A30 meeting on your mobile phone or PC to a nearby device by selecting **Add a room**.

Third-Party meeting: You can use the MeetingBar A10/A20/A30 (hereinafter referred to as MeetingBar AX0) Teams devices to join Third-Party meetings, such as Zoom and Cisco Webex. After you use the Zoom/Webex client to invite the Teams device, the meeting schedule will be listed on the MeetingBar AX0 device.

Before You Start

- You need to log in to your Microsoft Teams account in MeetingBar AX0.
- Firmware version 133.320.0.12 or later for MeetingBar A20/A30 and version 278.320.0.11 or later for MeetingBar A10 support joining meetings via Meeting ID. Please refer to the [release note](#) and download the latest firmware version.

Use via Remote Control

Join a Scheduled Meeting

NOTE

- Please ensure a meeting is reserved with the Teams client before using it.
- The device displays meeting information for the day.

The meeting of the organizer or invitees will be displayed on the right side of the interface. Click **Join** next to the corresponding meeting to enter the meeting.



Join with Meeting ID

1. Tap **Join with Meeting ID** to enter the meeting ID and password for the meeting.
2. Tap **Join Meeting**.
3. In the meeting, tap  > **Detail** to view the meeting ID and meeting password.

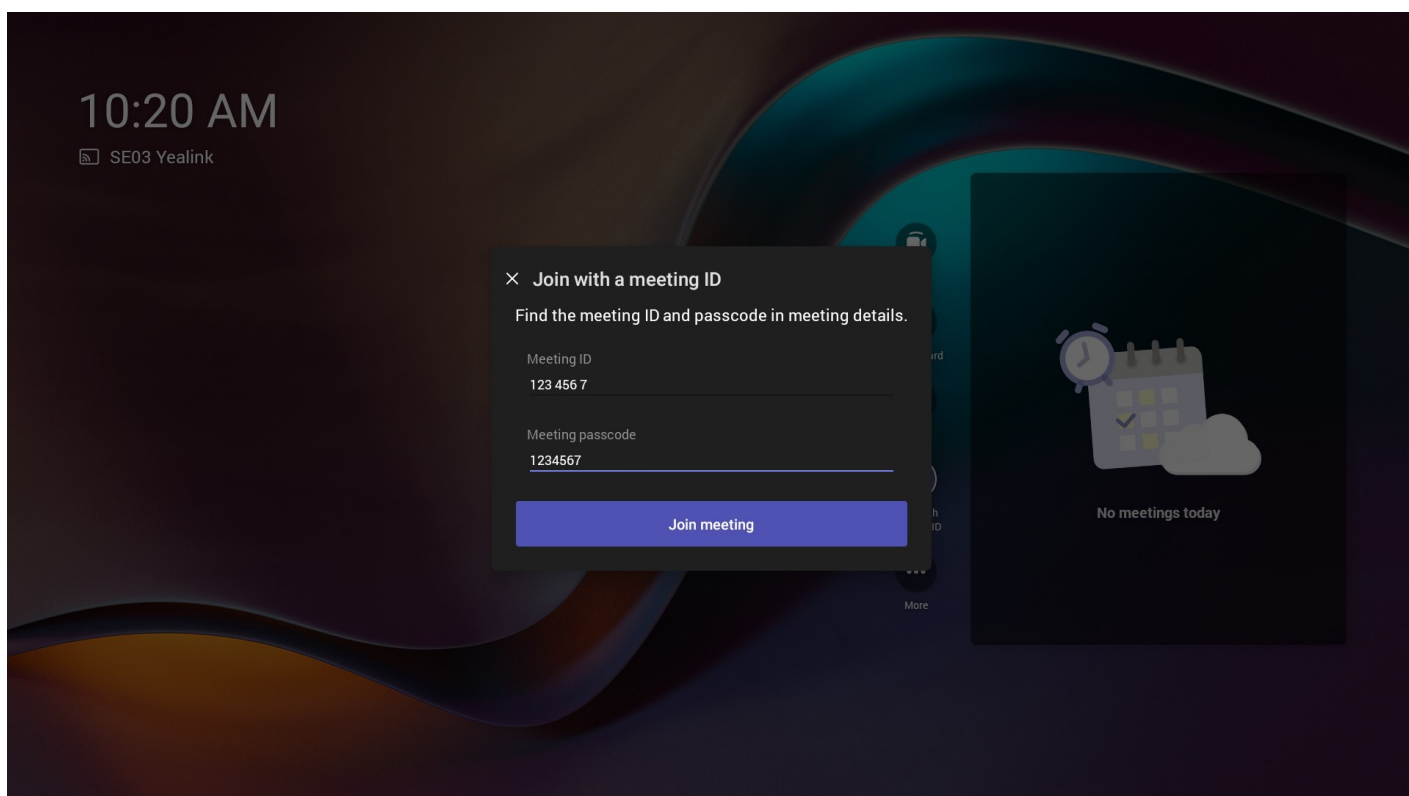

Proximity Join

When you choose the **Audio and Video Settings** to join a meeting, you can connect to a nearby meeting room and use its audio and video devices.

NOTE

- Please ensure you **enable Bluetooth** on the MeetingBar AX0 and the mobile phone/PC before use.
- Please ensure the domain names of the Teams accounts used on the MeetingBar AX0 and the mobile phone/PC are the same. For example, the MeetingBar AX0 log in to the test01@yealink.com and the PC log in to test02@yealink.com accounts respectively.

Scenario 1: When joining a meeting

You can join the meeting through the calendar/invitation link/meeting ID on the Teams mobile/PC client. For more information, please refer to [Join a meeting in Teams](#). The following use the **Calendar** to join a meeting.

1. Go to **Join now > Join and add a room** on the mobile client, then select the desired device.

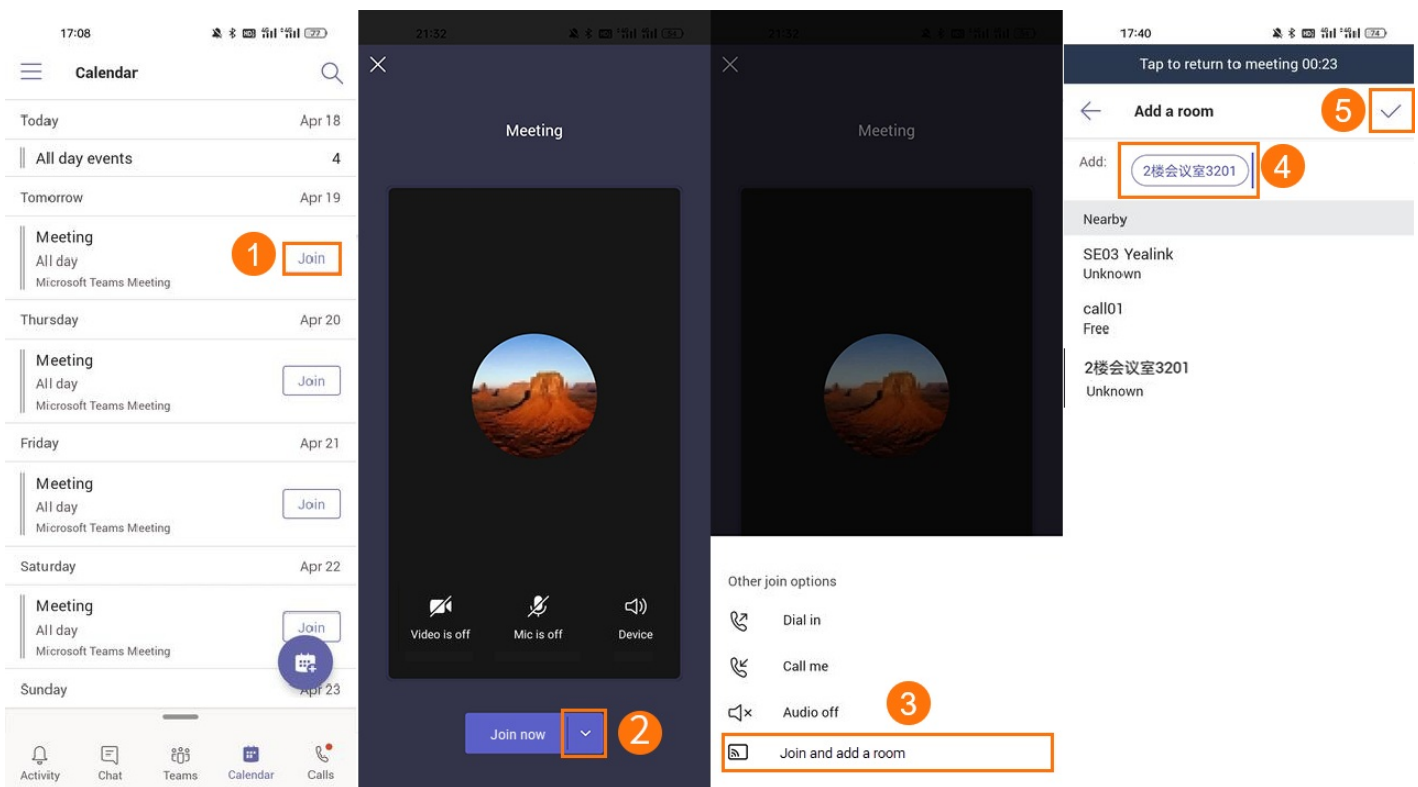

2. Go to **Room audio > Join now** on the PC client.

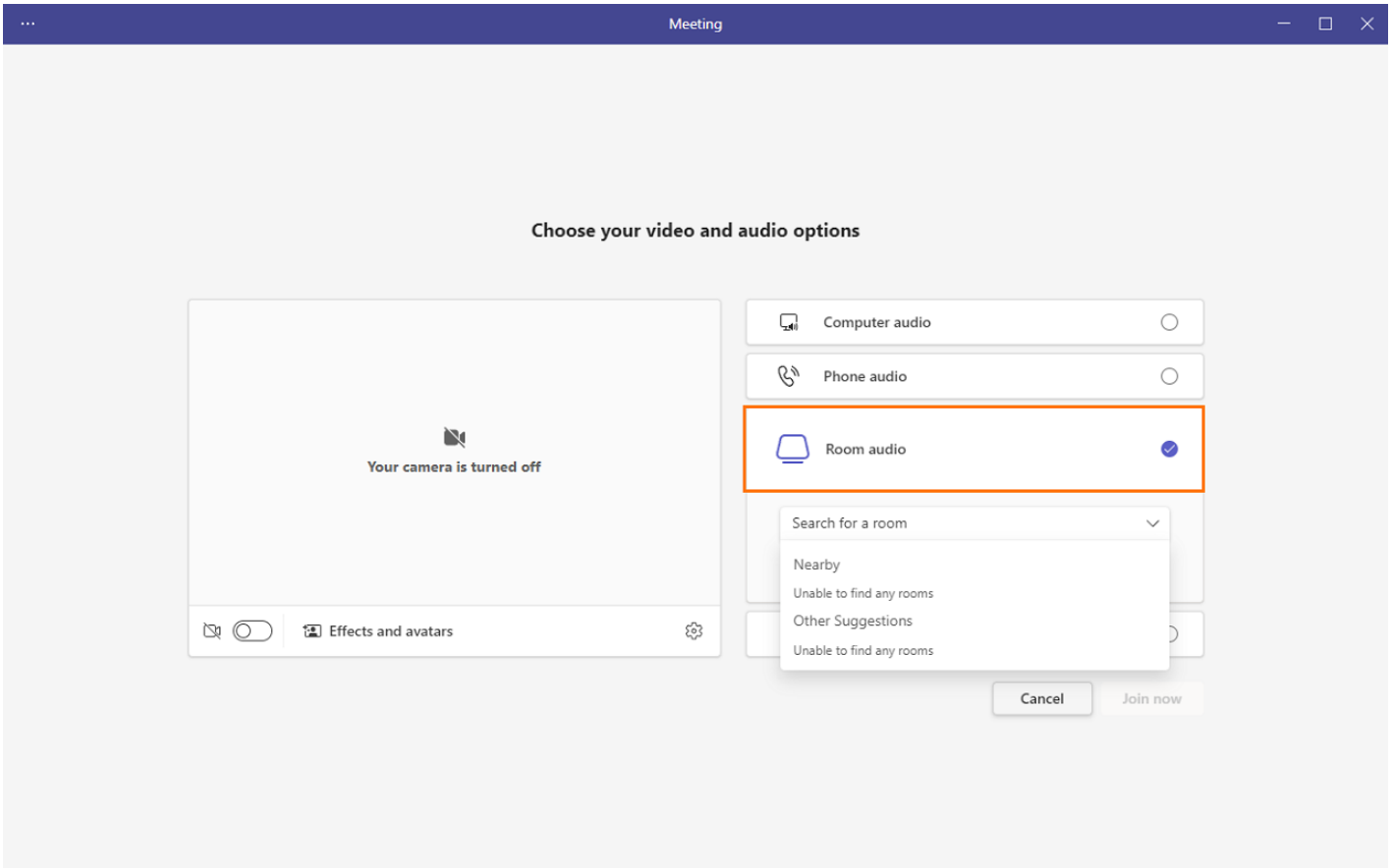

Scenario 2: During a meeting

Go to **Manage > Add a room** on the mobile client to select the desired room.

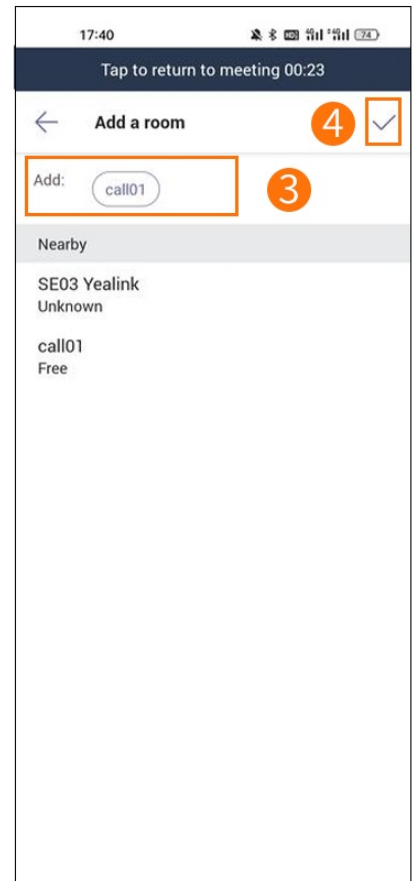
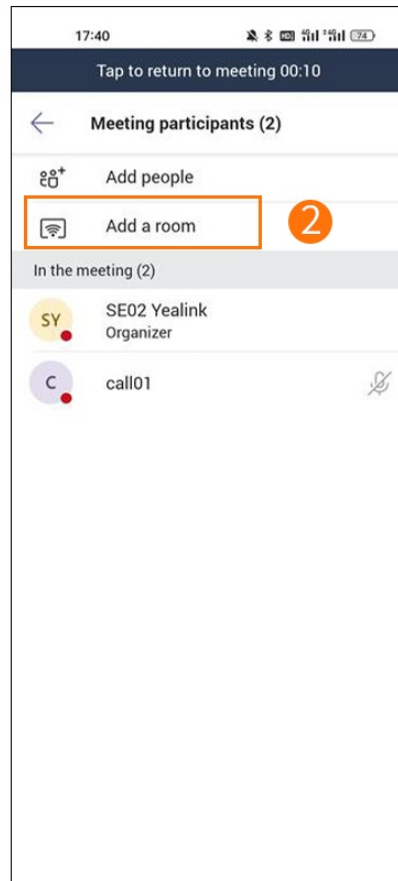
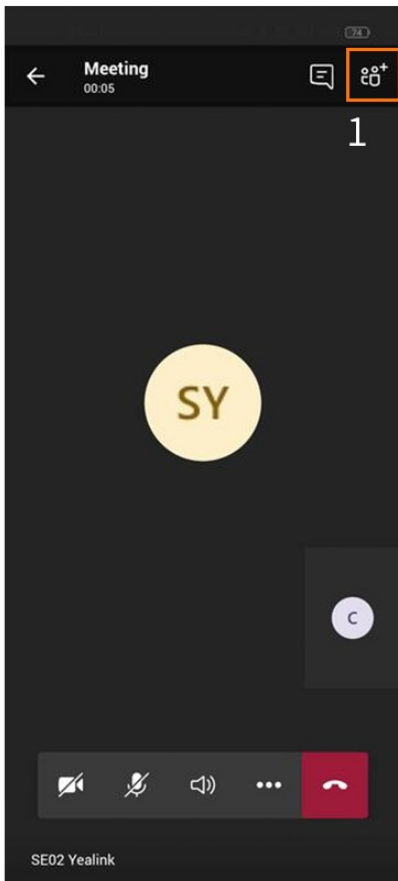

Effect Demonstration

By default, the MeetingBar AX0 automatically accepts nearby meeting invitations. When the MeetingBar AX0 in the meeting room detects a **Proximity Join** initiated by the mobile phone/PC, it will automatically enter the meeting. If you want to accept nearby meeting invitations manually, please refer to [How do I set up to accept nearby meeting invitations manually?](#) And you can use the remote control to control the meeting room device to accept meeting invitations.



Join Third-Party Meetings

NOTE

- Before using Third-Party meetings, please ensure the administrator has enabled **Allow access to Third-Party meetings**. Please refer to [Enable Teams Rooms devices to join Third-Party meetings](#) for more information.
- Please ensure your device's time zone is the same as your local time zone.

1. Go to **More > Settings > Meeting** to enable the corresponding Third-Party meeting.

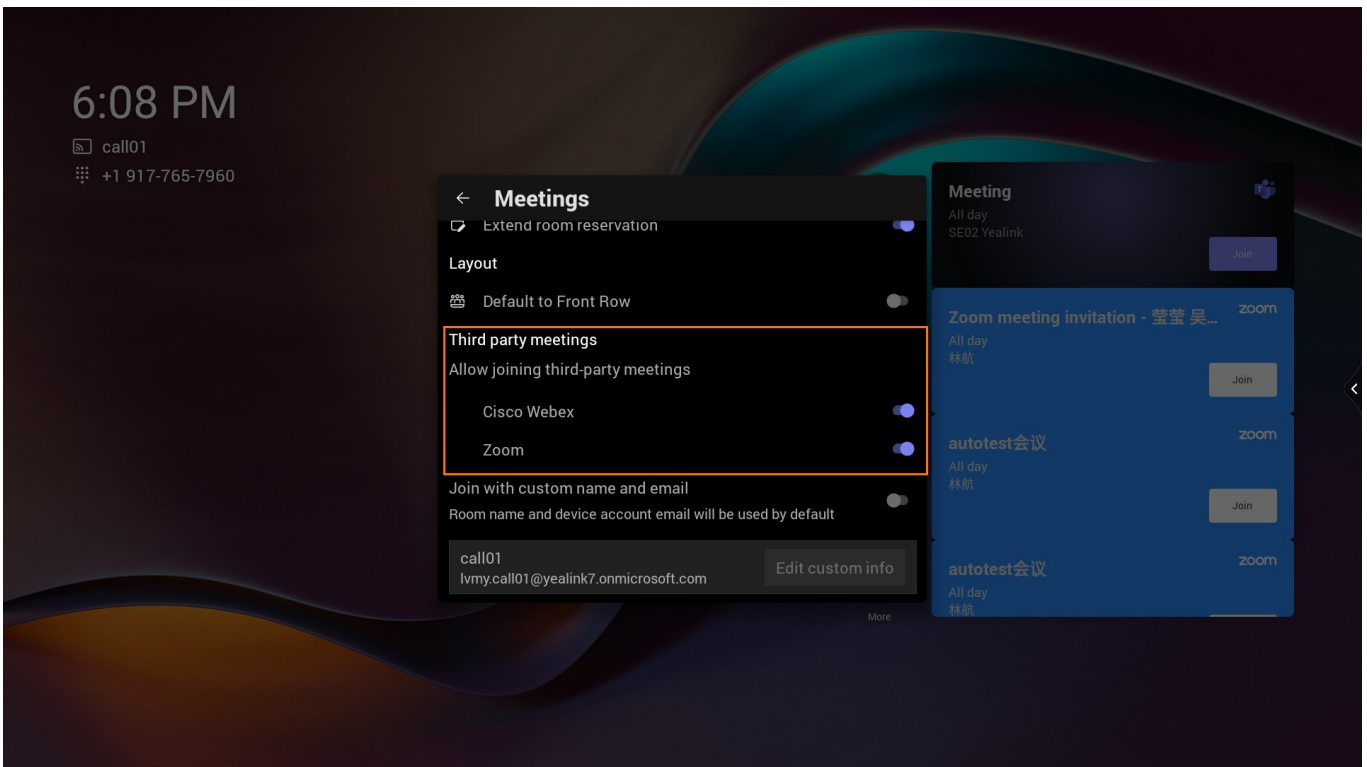

2. After successfully inviting the account logged in to MeetingBar AX0 on the Zoom/Webex client, the meeting information will be listed on the interface of MeetingBar AX0.

3. Select **Join** to enter the meeting.



NOTE

You can not share the screen on the MeetingBar AX0 in a Third-Party meeting, but the other party can share the screen on the Zoom/Cisco Webex client. For more information, please refer to [Zoom](#) and [Cisco Webex](#).

Use via CTP18 Control**Join a Scheduled Meeting****NOTE**

The device displays meeting information for the day.

Select the meeting displayed on the right side of the interface, and tap **Join** to enter the meeting.

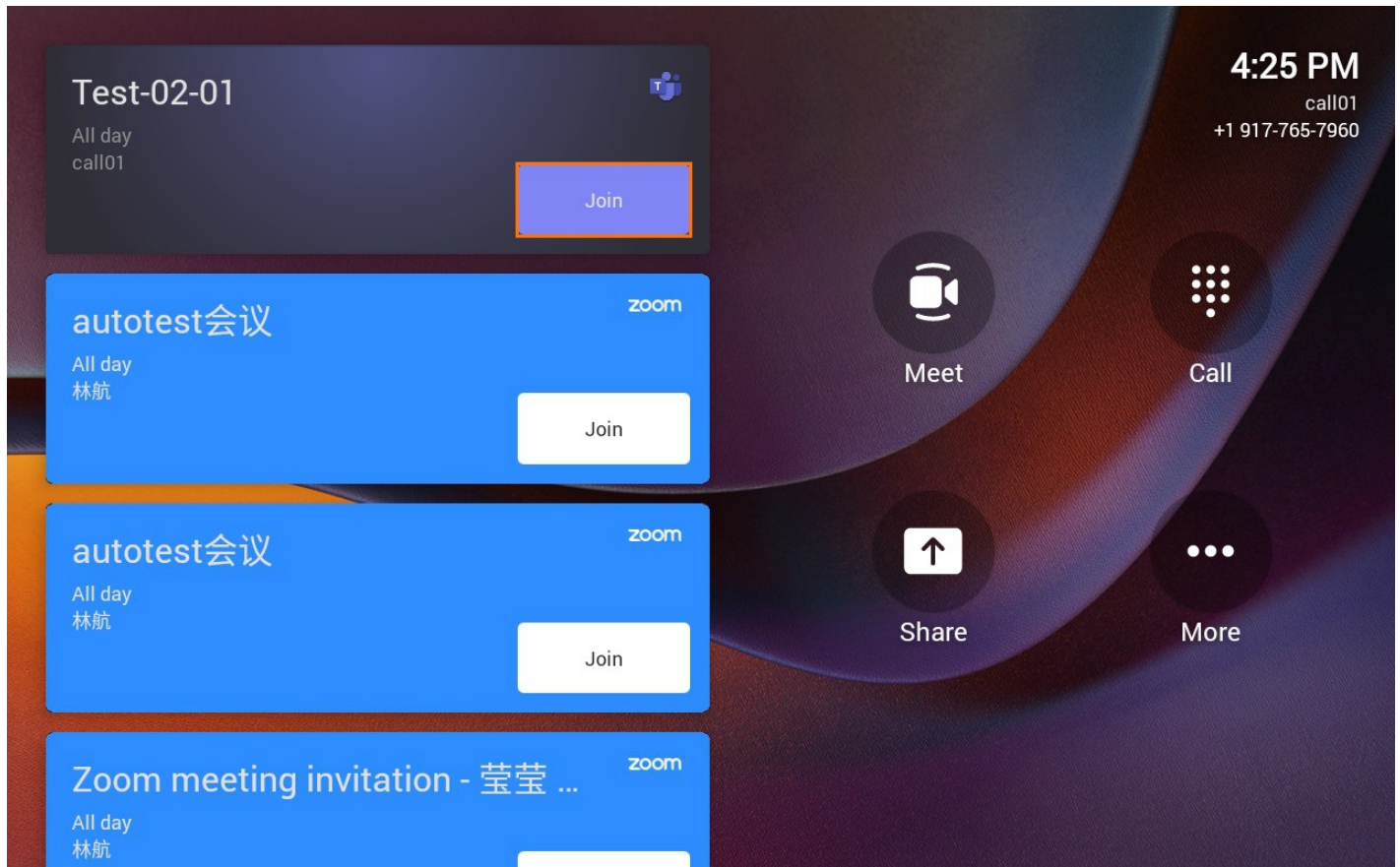
**Join with Meeting ID**

1. Tap **Join with Meeting ID** to enter the meeting ID and password for the meeting.
2. Tap **Join Meeting**.
3. In the meeting, tap **More** > **Detail** to view the meeting ID and meeting password.

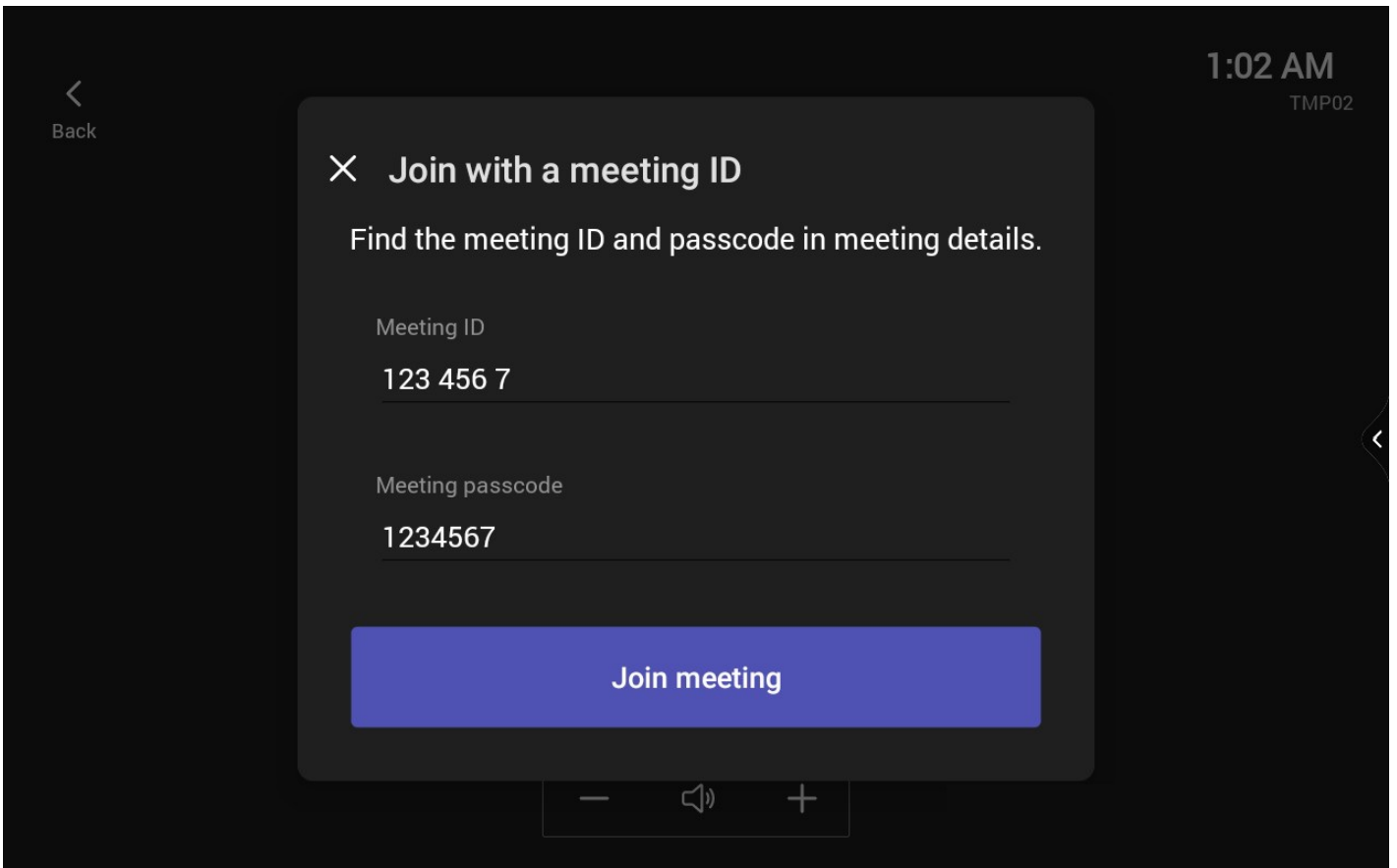

Proximity Join

When you choose the **Audio and Video Settings** for join a meeting, you can connect to a nearby meeting room and use its audio and video devices.

NOTE

- Please ensure you **enable Bluetooth** on the MeetingBar AX0 and the mobile phone/PC before use.
- Please ensure the domain names of the Teams accounts used on the MeetingBar AX0 and the mobile phone/PC are the same. For example, the MeetingBar AX0 and the PC log in to the test01@yealink.com and test02@yealink.com accounts respectively.

Scenario 1: When joining a meeting

You can join the meeting through the calendar/invitation link/meeting ID on the Teams mobile/PC client. For more information, please refer to [Join a meeting in Teams](#). The following takes the calendar to join a meeting as an example.

Go to **Join now** > **Join and add a room** on the mobile client, then select the desired device.

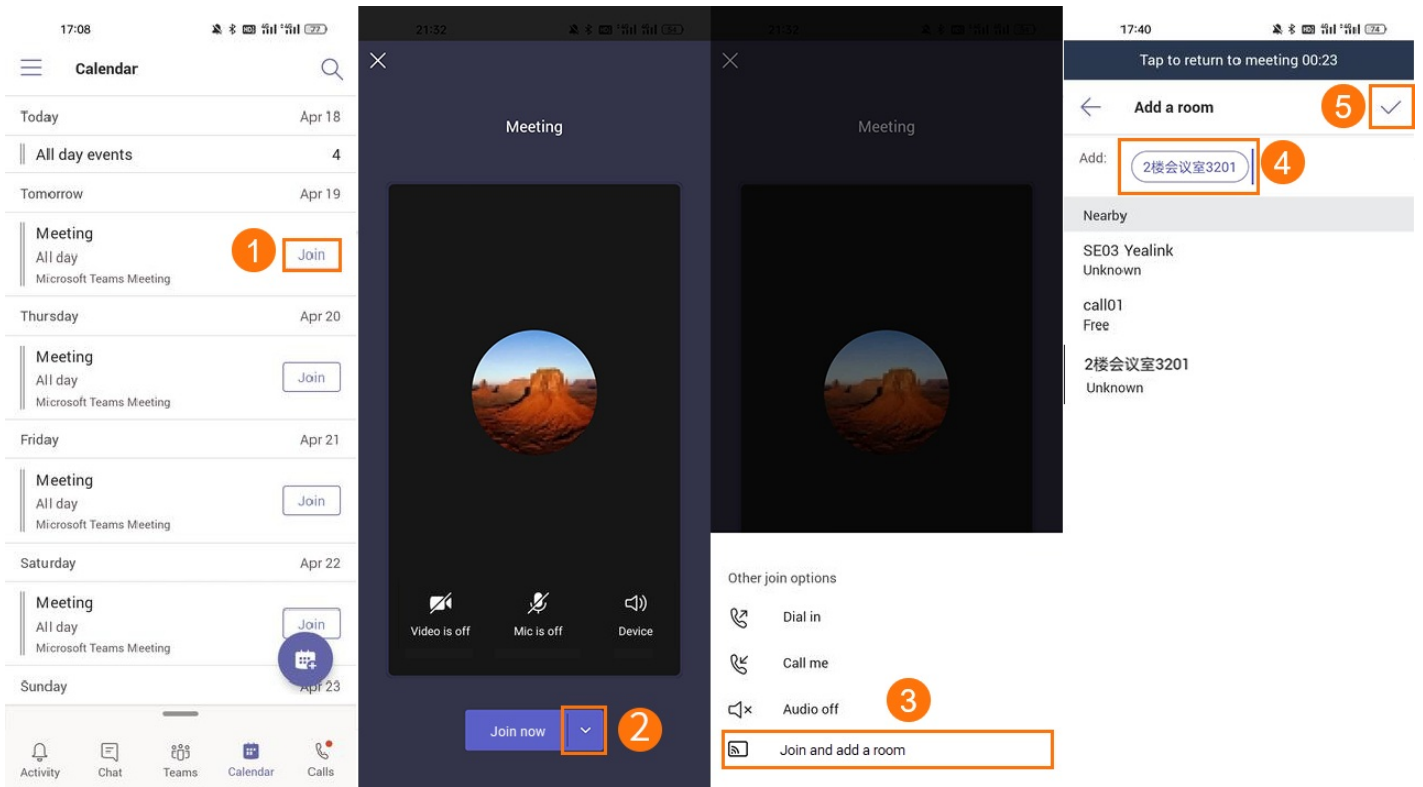

Go to **Room audio** > **Join now** on the PC client.

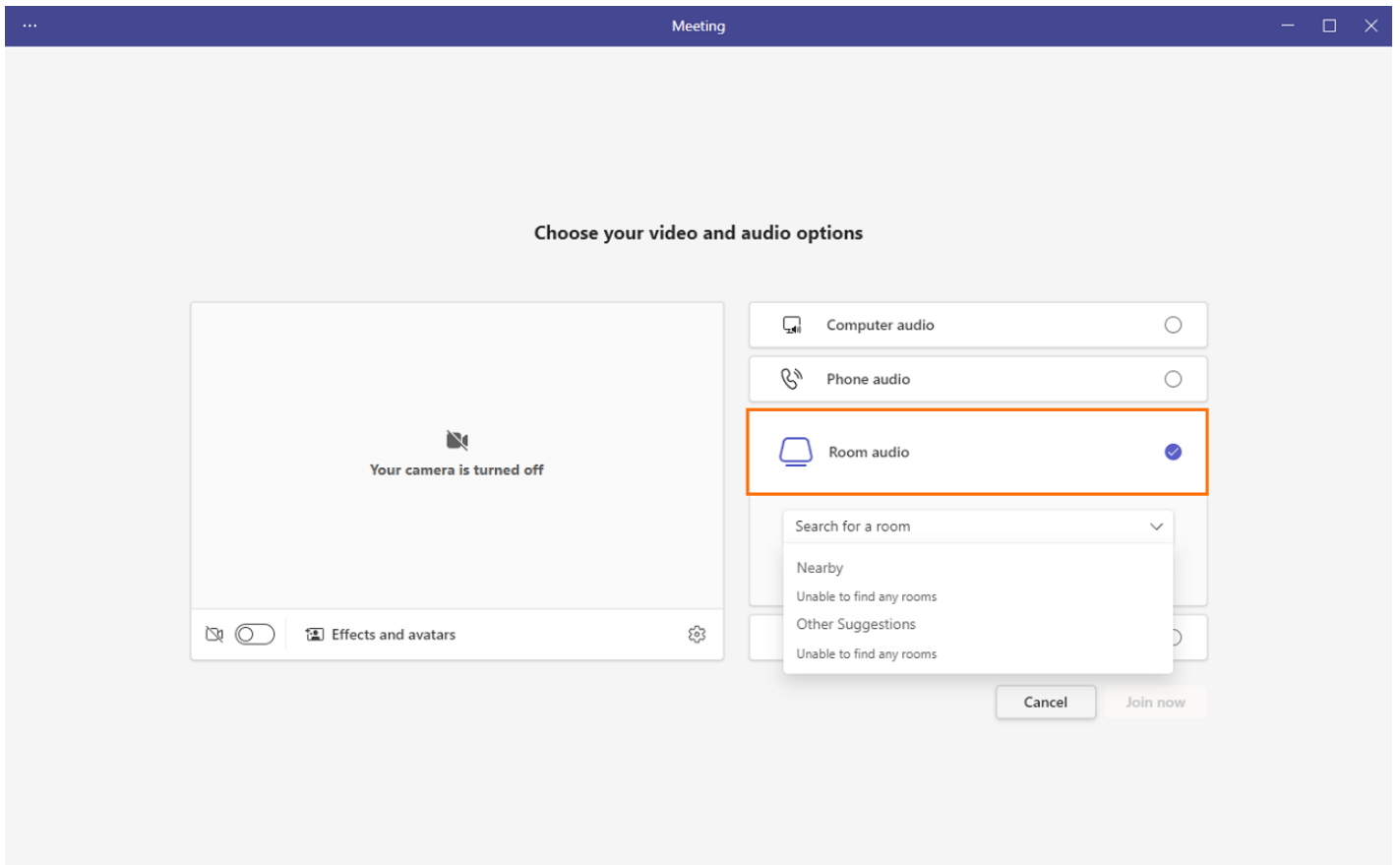

Scenario 2: During a meeting

Go to  > **Add a room** on the mobile client.

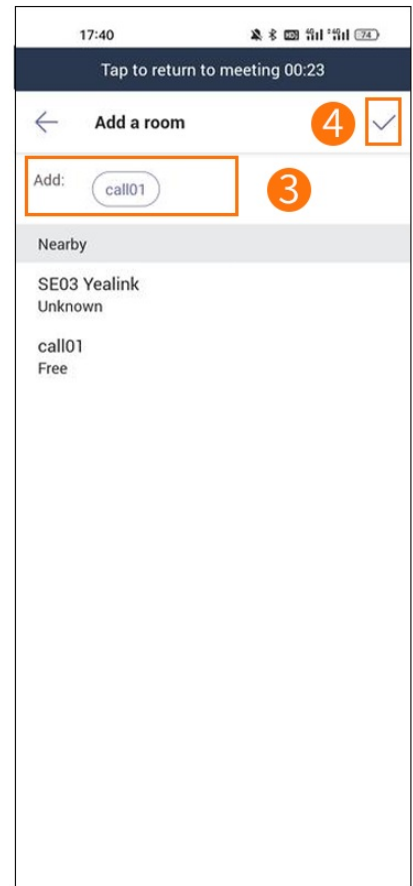
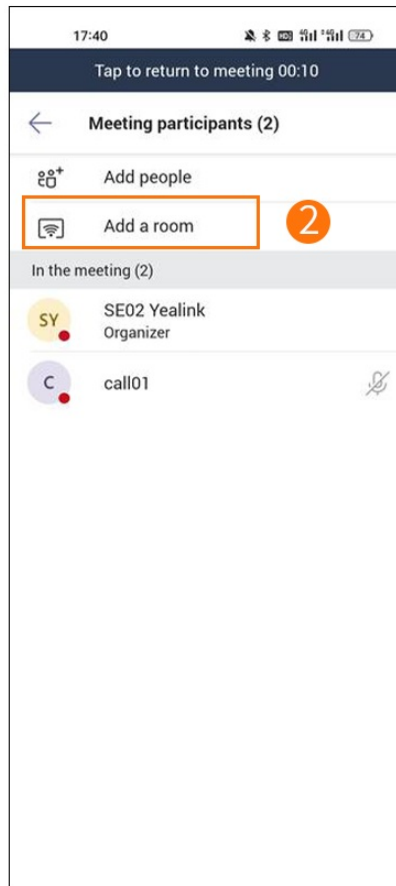
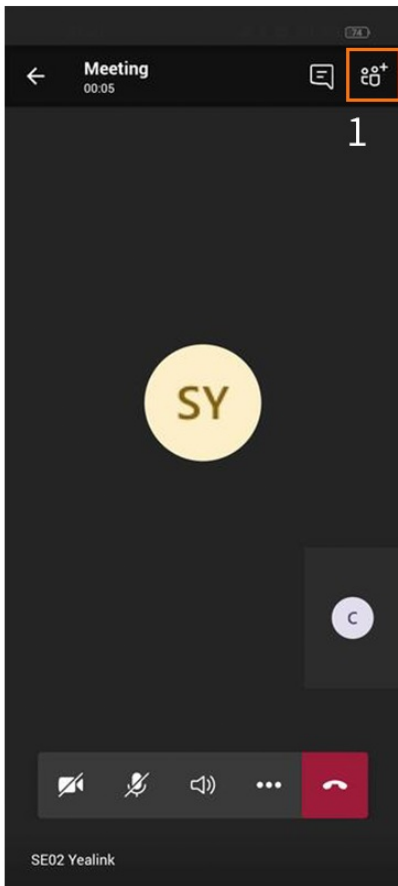

Effect Demonstration

By default, the MeetingBar AX0 automatically accepts nearby meeting invitations. When the MeetingBar AX0 in the meeting room detects a **Proximity Join** initiated by the mobile phone/PC, it will automatically enter the meeting. If you want to accept nearby meeting invitations manually, please refer to [How do I set up to accept nearby meeting invitations manually?](#) And you can use the CTP18 to control the meeting room device to accept meeting invitations.



Join Third-Party Meetings

NOTE

- Before using Third-Party meetings, please ensure the administrator has enabled **Allow access to Third-Party meetings**. Please refer to [Enable Teams Rooms devices to join Third-Party meetings](#) for more information.
- Please ensure your device's time zone is the same as your local time zone.

1. Go to **More > Settings > Meeting** to enable the corresponding Third-Party meeting.

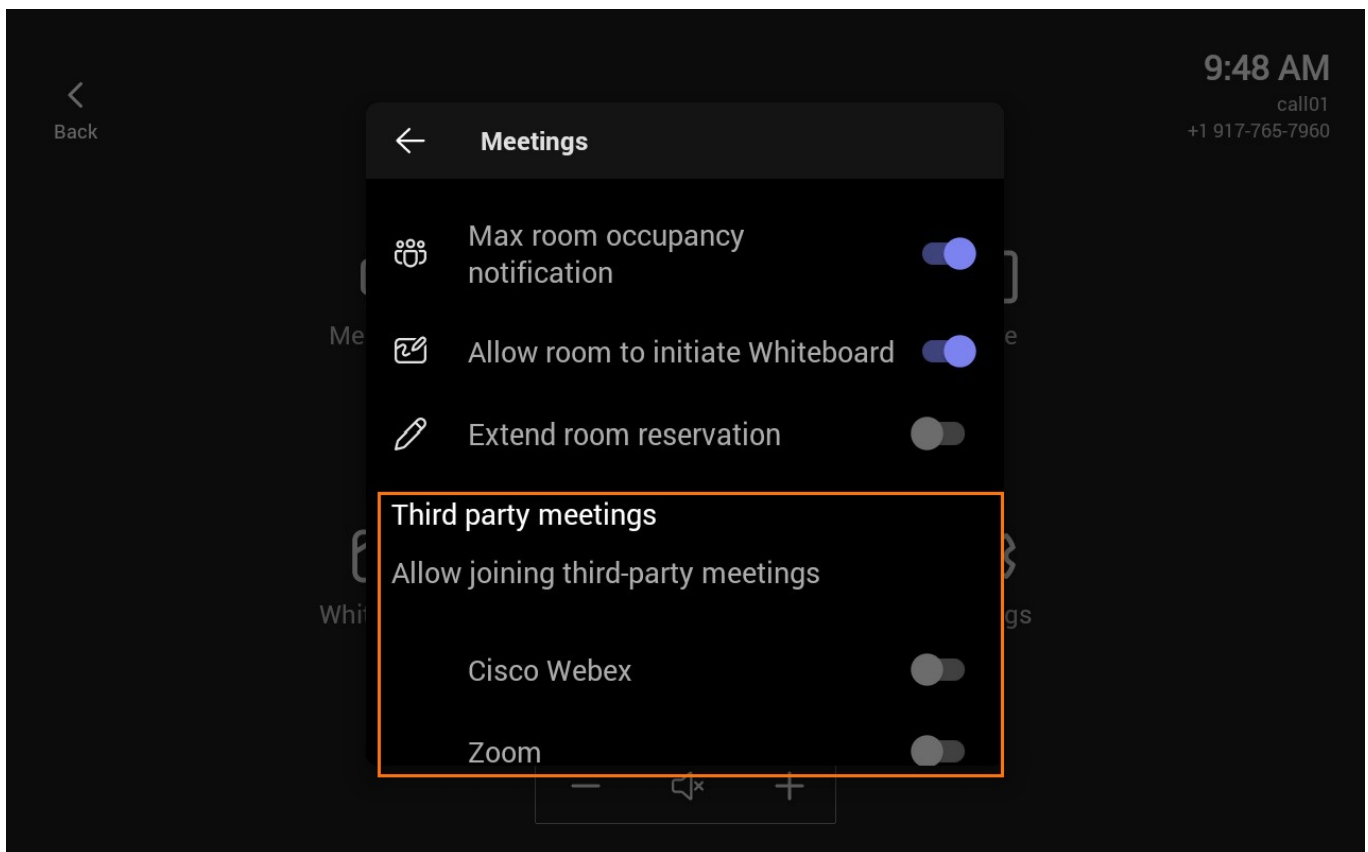

2. After successfully inviting the account logged in to MeetingBar AX0 on the Zoom/Webex client, the meeting will be listed on the interface this MeetingBar AX0.

3. Select **Join** to enter the meeting.

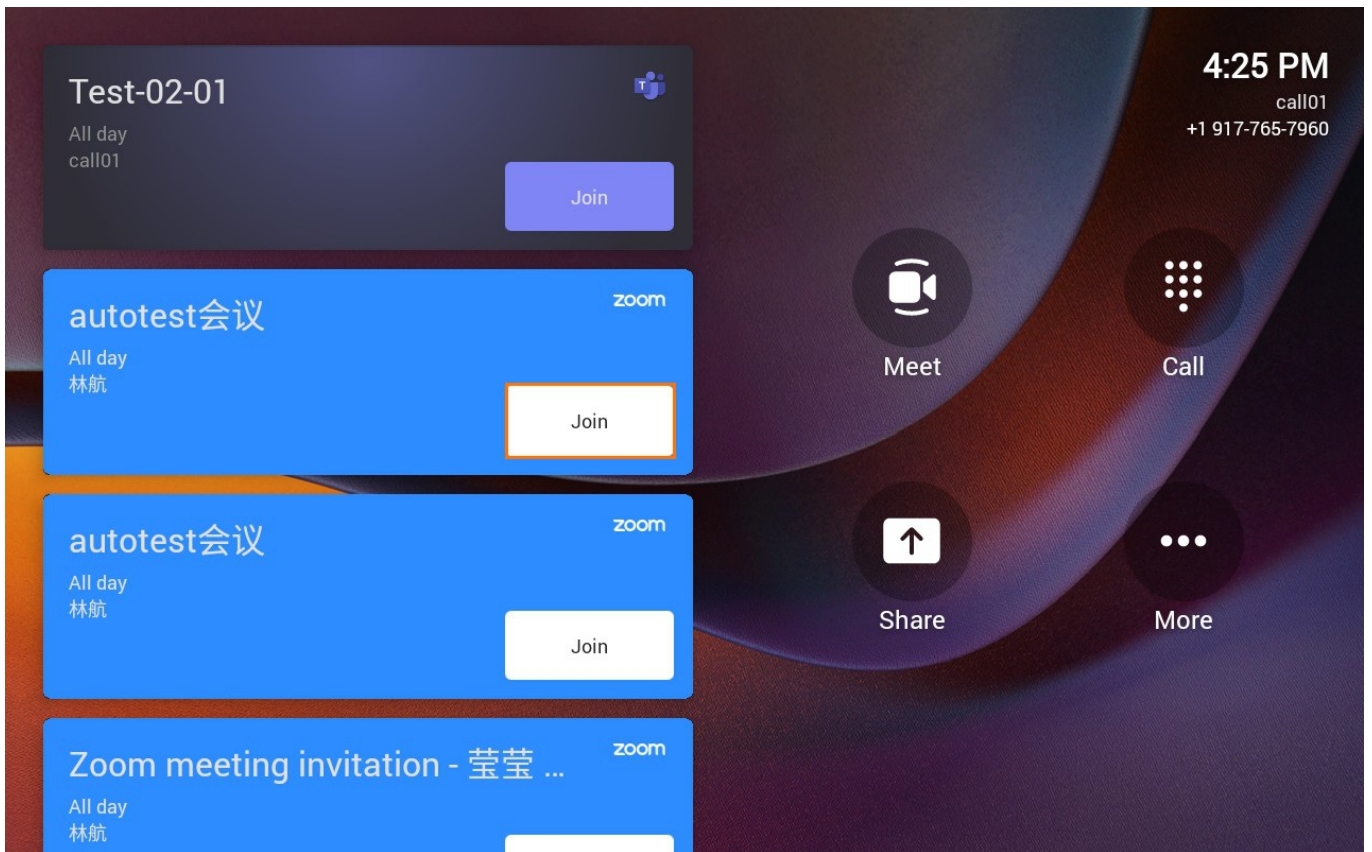

NOTE

MeetingBar AX0 Screen sharing cannot be performed in a Third-Party meeting, but the other party can share the screen on the Zoom/Cisco Webex client. For more information, please refer to [Zoom](#) and [Cisco Webex](#).

FAQ

Does the MeetingBar AX0 support joining conferences through conference ID?

Yes. Please refer to [What's new in Microsoft Teams devices](#) for more information.

Why can't other people receive the invitation when I invite them to join the scheduled meeting on the Teams app for PC?

Troubleshooting suggestions:

Step 1: Check the mailbox corresponding to the Teams account to see if the corresponding meeting invitation email has been sent out (the Teams client meeting invitation is sent through the mailbox).

Step 2: If the invitation has been sent, contact invitees to check whether they have received the emails. Sometimes, the email might be landed in the **Spam Folder** due to some email restrictions of invitees. If the email is not sent, please contact the system administrator. If the invitees have email restrictions, they need to contact their email administrator to change the restrictions so the invitation email can be received.

How do I set up to manually accept nearby meeting invitations?

On the CTP18 or with the remote control, go to **More > Settings > Meetings** to disable **Automatically accept proximity-based meeting invitations**.

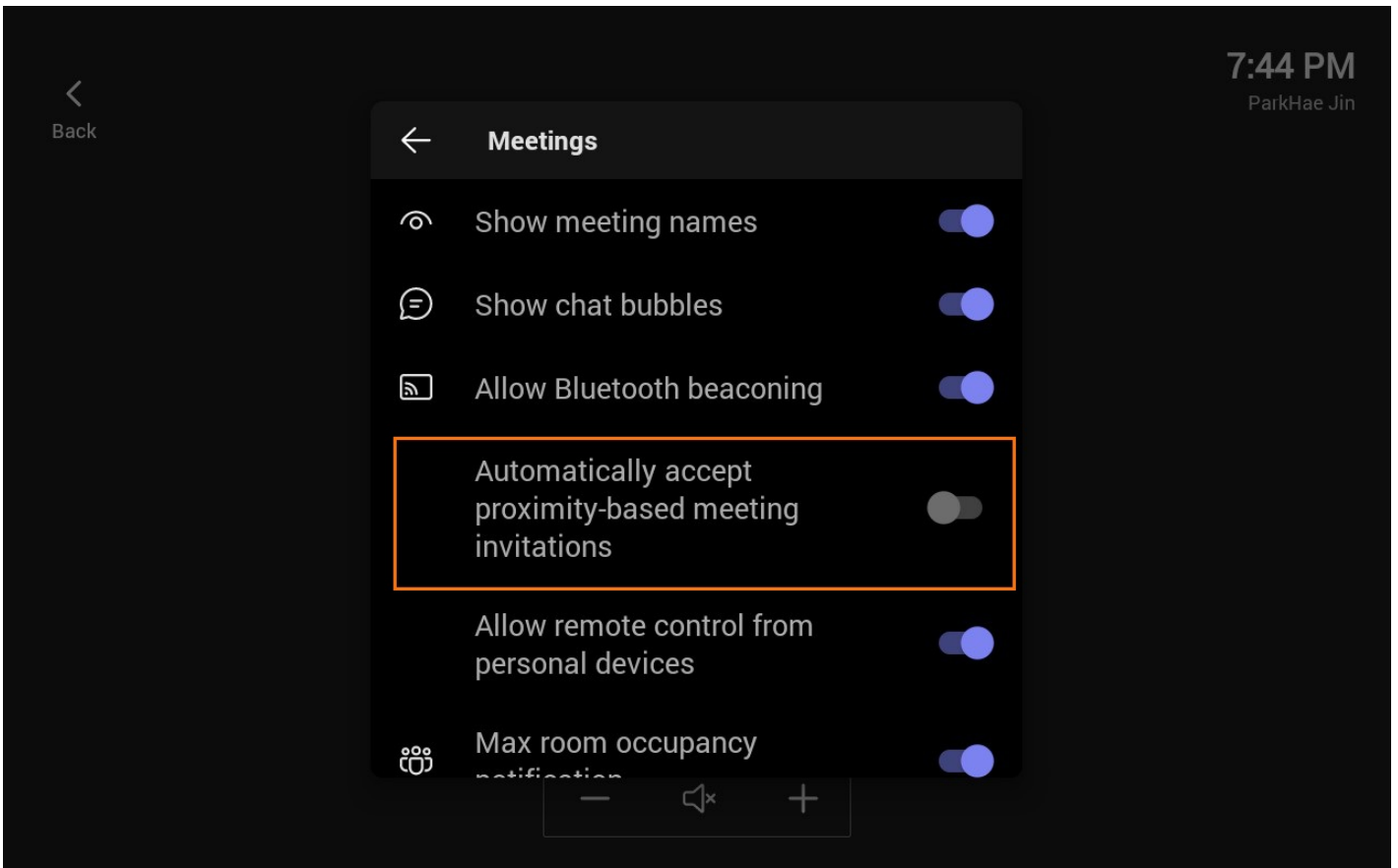

Can I disable the camera when joining a meeting?

The camera is enabled by default when joining a meeting, and you can disable  after joining the meeting.

Invite Participants

Introduction

You can search by entering your participant account to invite them to a (MeetingBar A10/MeetingBar A20/MeetingBar A30) meeting.

For the latest Teams features, please refer to [What's new in Microsoft Teams](#).

Use via Remote Control

1. Tap  in the bottom menu bar.
2. Tap **Add participants** to search for members.

3. Enter the invitee' s name to send the meeting invitation.



Use via CTP18 Control

1. Select **Invite someone** to the meeting.
2. Enter the invitee' s name to send a meeting invitation.

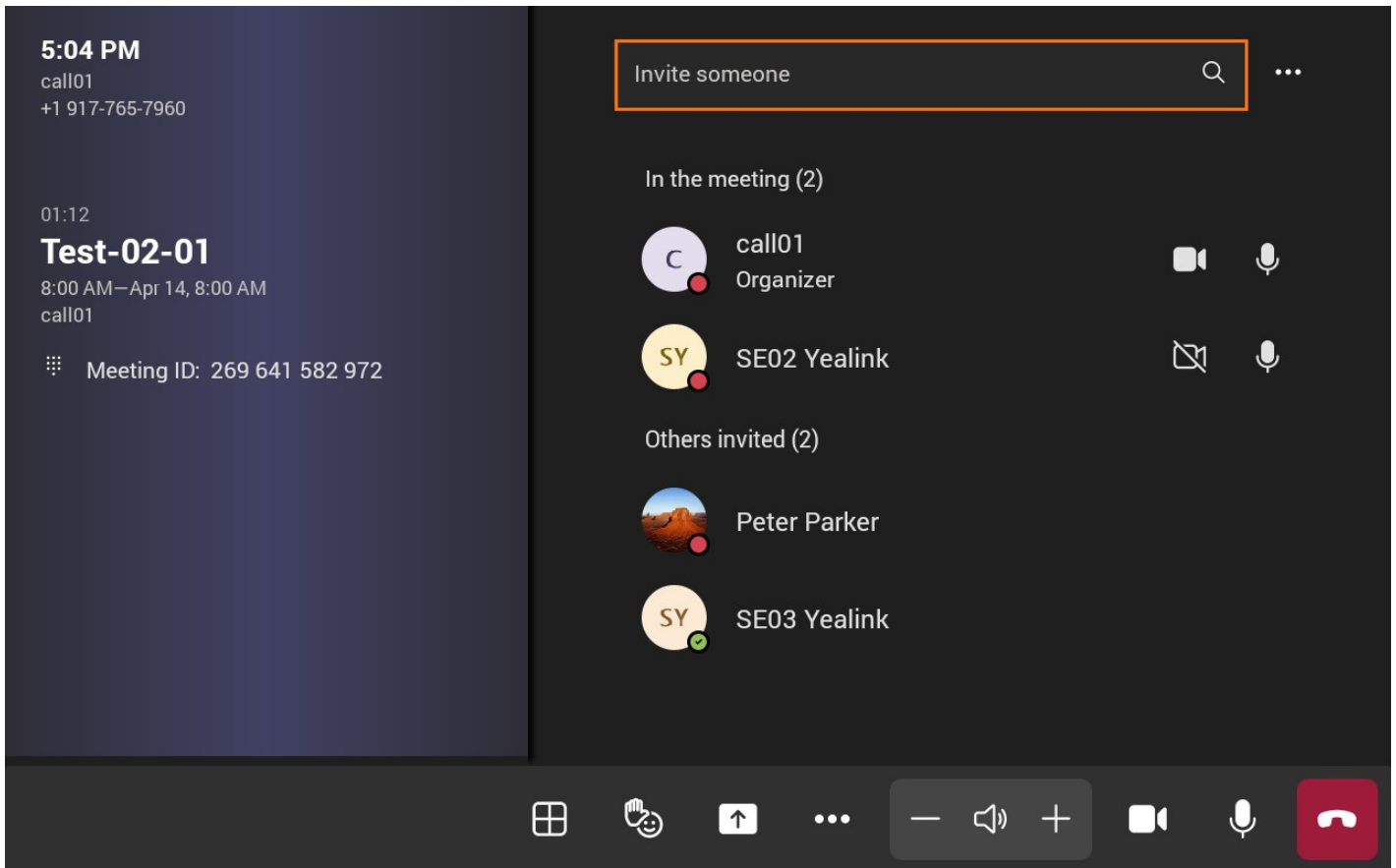

Manage Participants

Introduction

As a meeting host, you can pin, spotlight, mute, invite or remove (MeetingBar A10/MeetingBar A20/MeetingBar A30) participants.

For the latest Teams features, please refer to [What's new in Microsoft Teams](#).

Use via Remote Control

Spotlight Participant

When you set a participant to **spotlight for every**, the participant is displayed on a large screen in everyone's video screen.



Mute Participant

You can mute a participant's microphone, and only the participant can unmute their microphones.

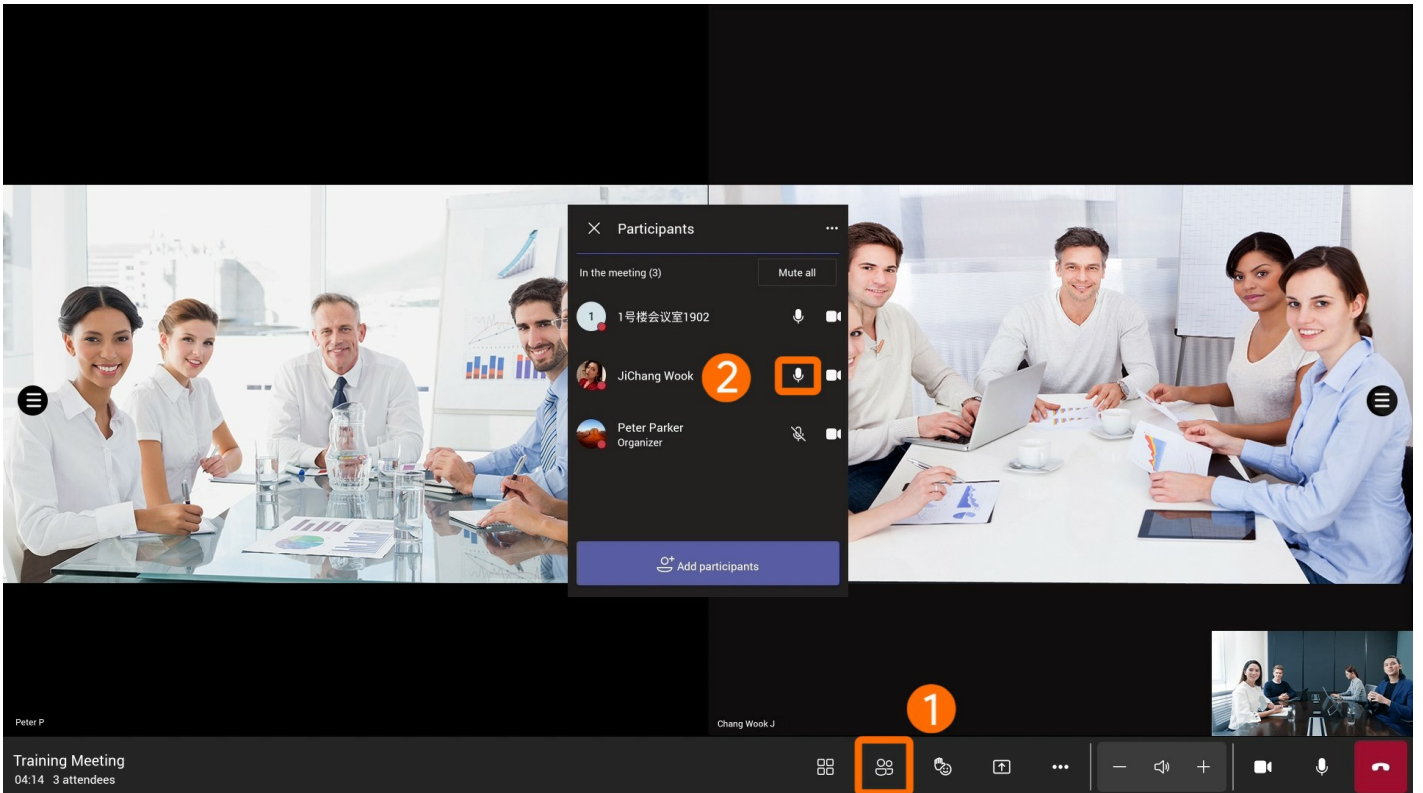

Mute all participants.

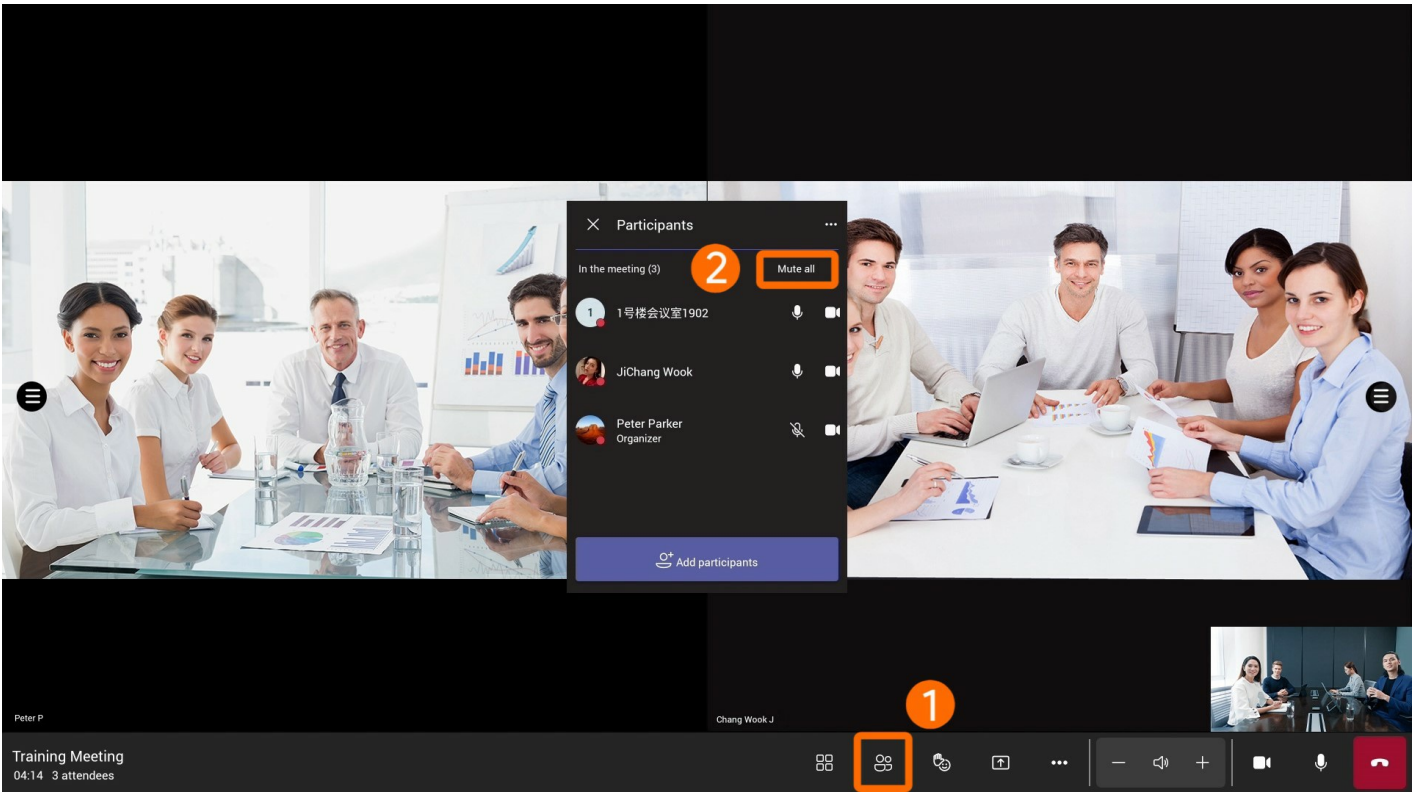

Remove Participant

Select **Remove from meeting** to remove a participant.

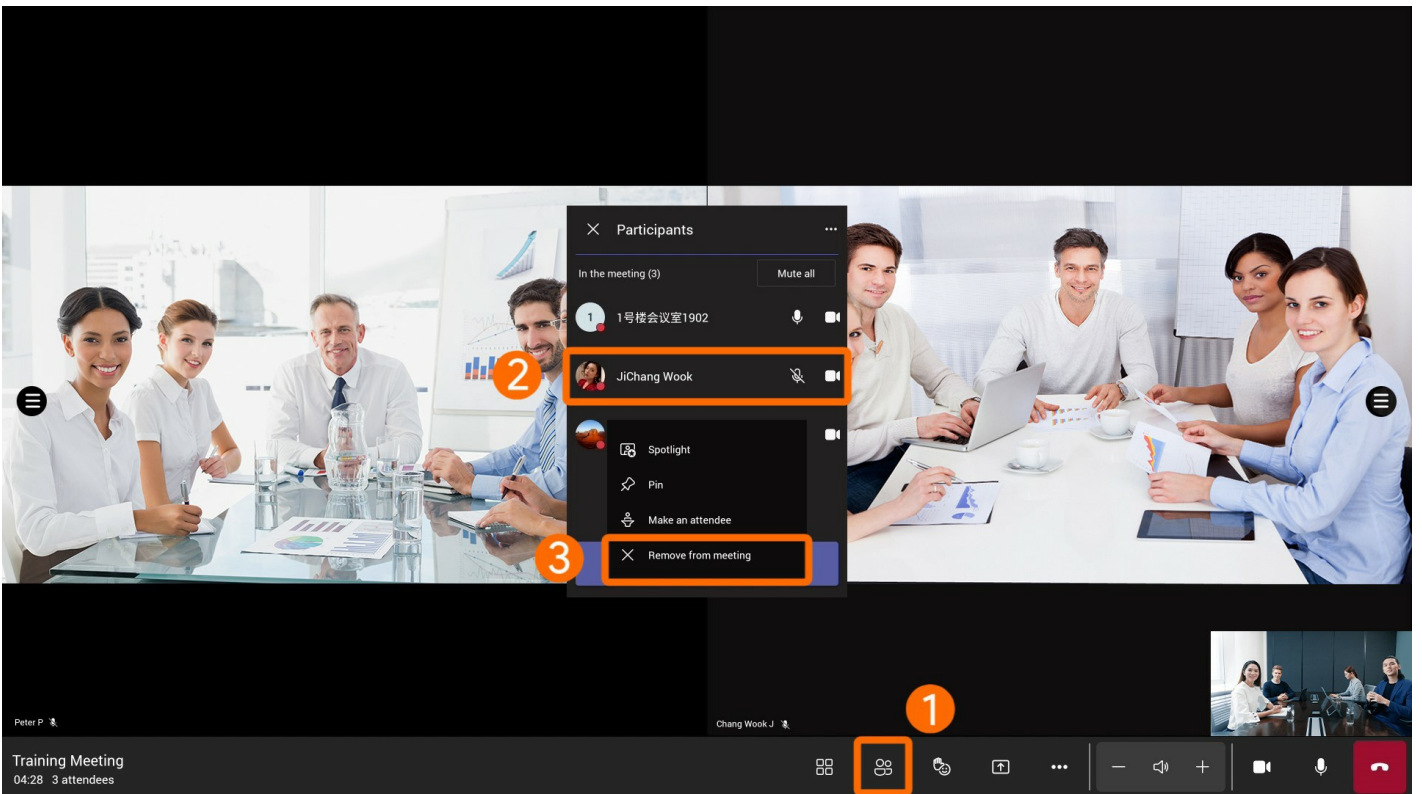

Set as Attendee

1. Select a participant in the meeting.
2. Set to **Make an attendee**.
3. After setting the participant as an attendee, you can restrict them from using the microphone, camera, etc.

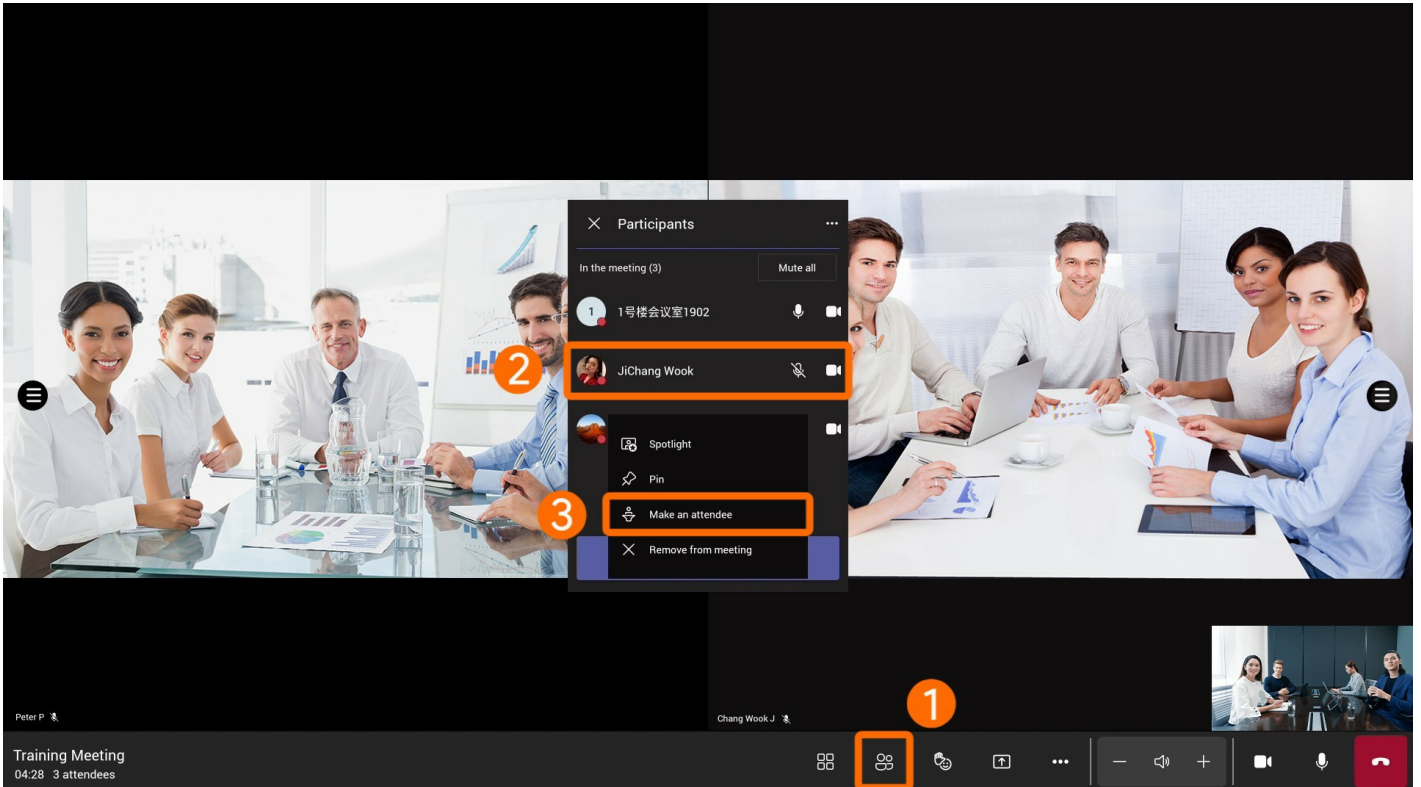

Use via CTP18 Control

Spotlight Participant

When you set a participant to **spotlight for every**, the participant is displayed on a large screen in everyone's video screen.

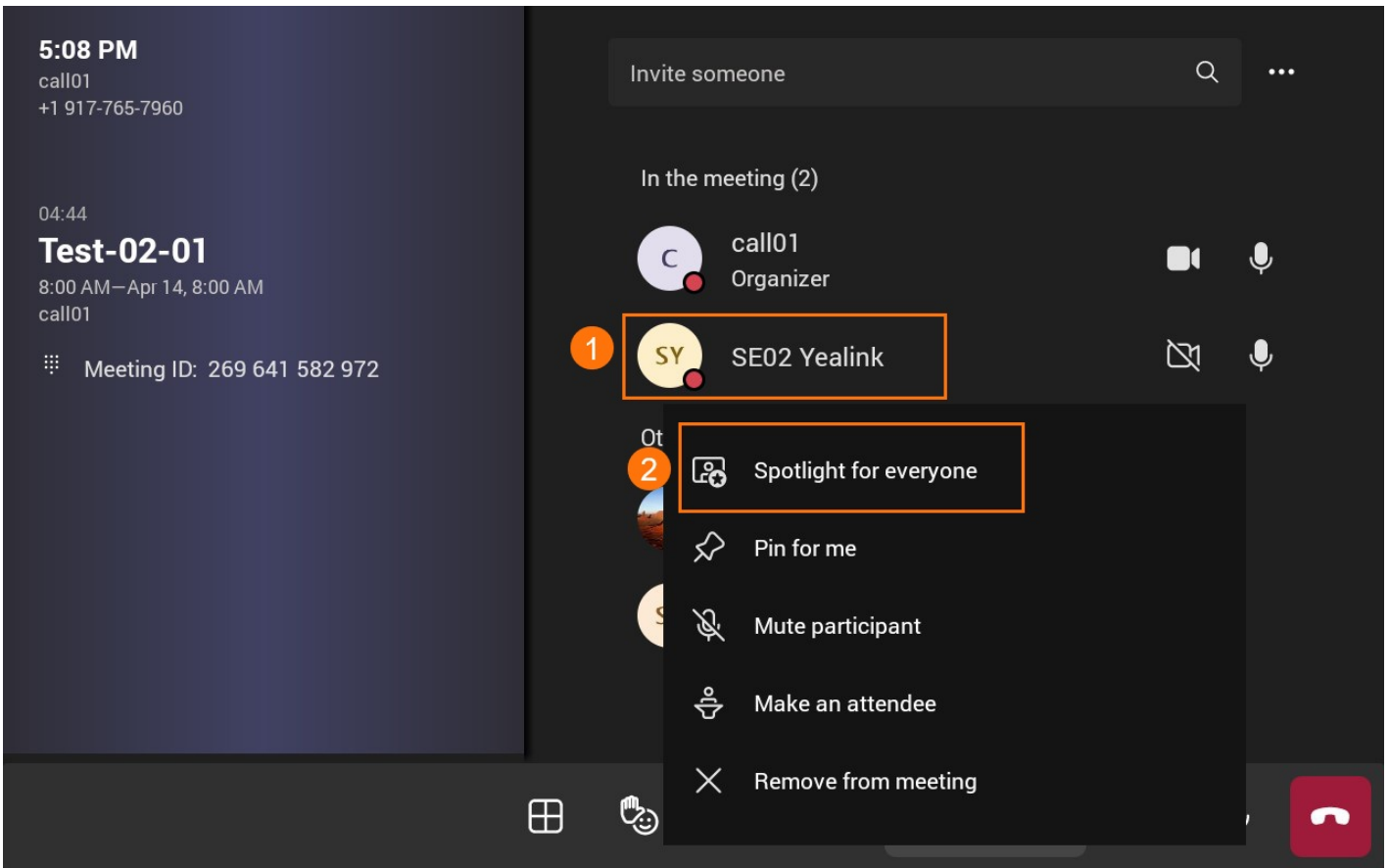

Mute Participant

You can mute a participant's microphone, and only the participant can unmute their microphone.

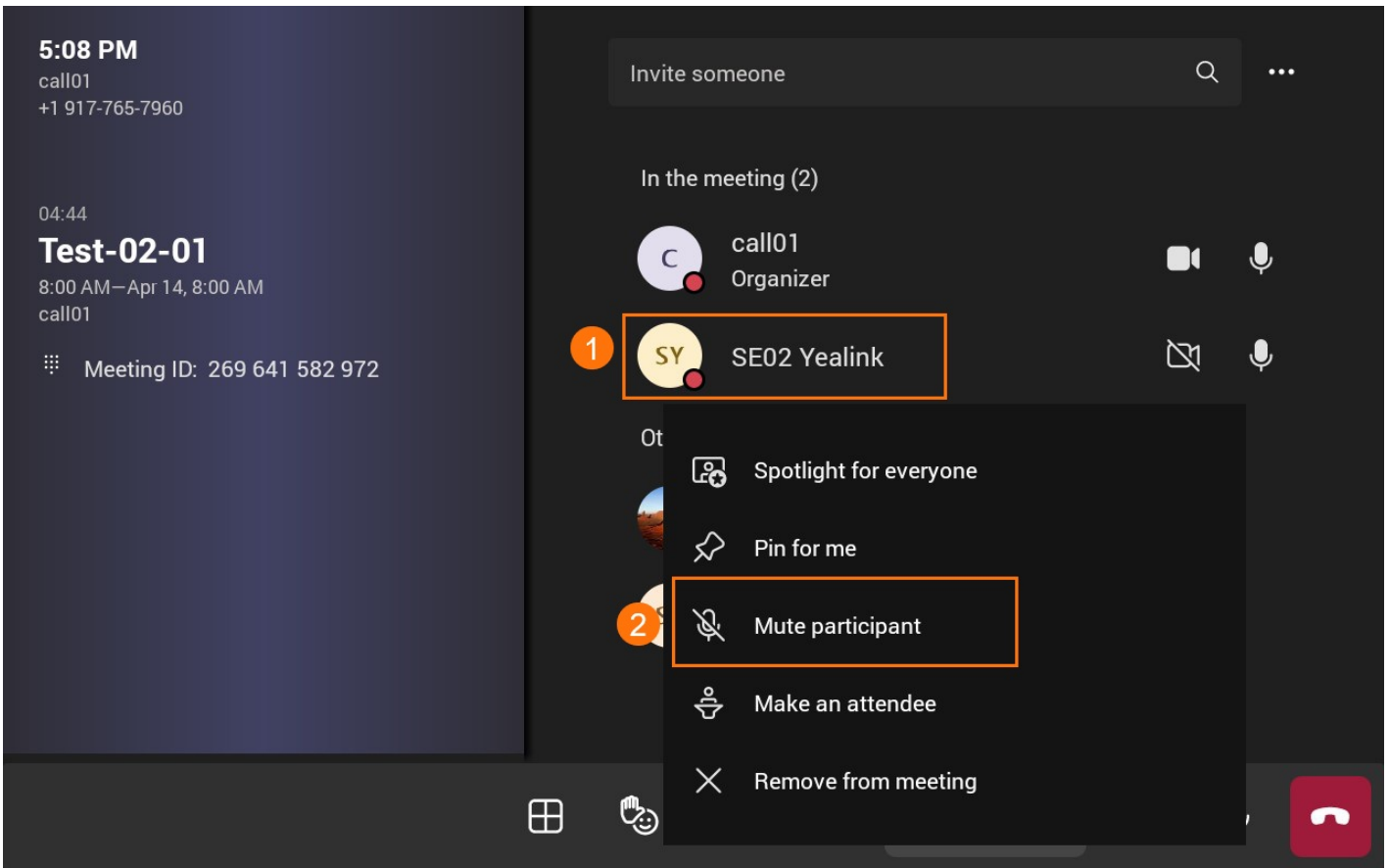

Remove Participant

Select **Remove from meeting** to remove the participant.

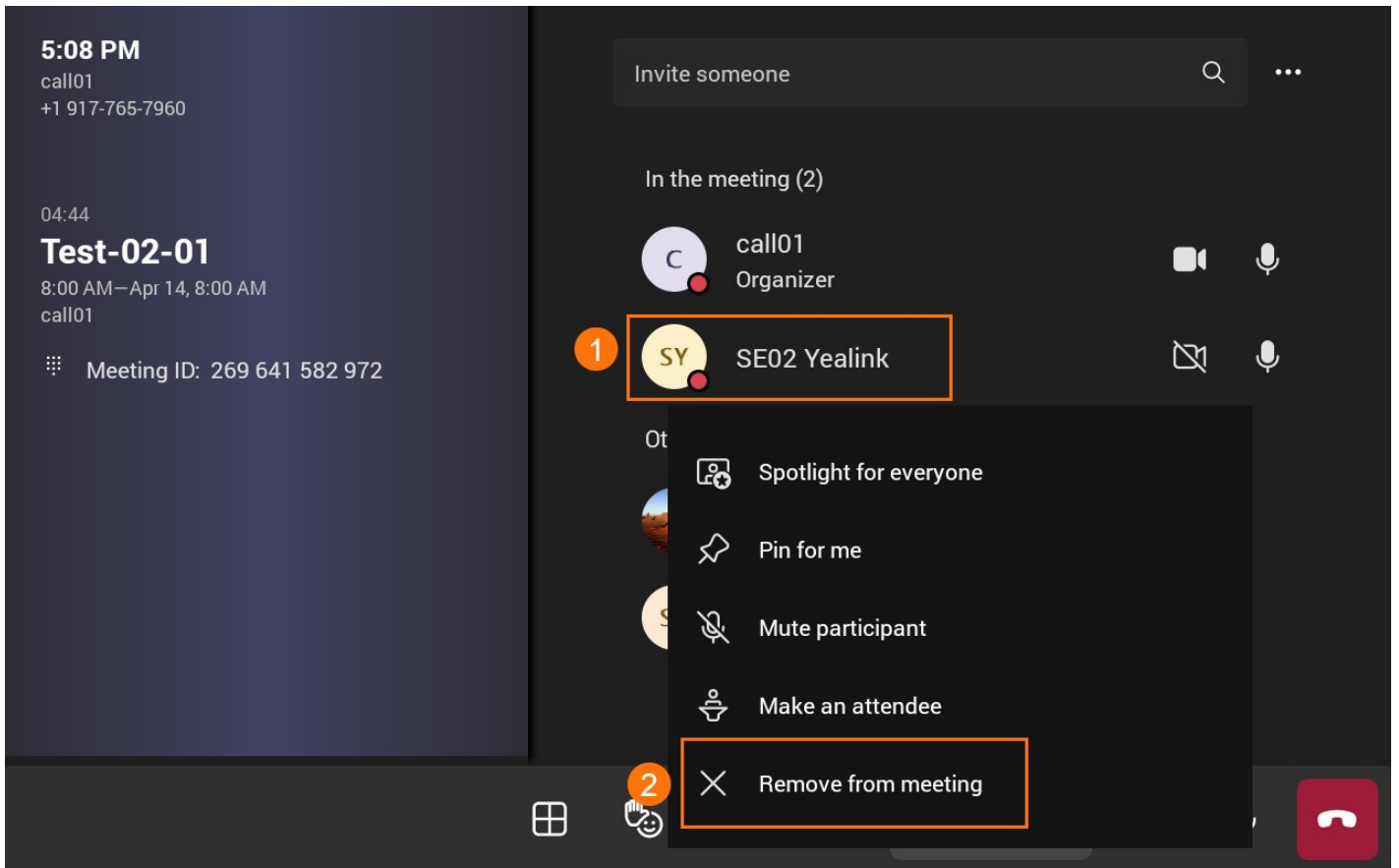

Set as Attendee

1. Select a participant in the meeting.
2. Set to **Make an attendee**.
3. After setting the participant as an attendee, you can restrict them from using the microphone, camera, etc.

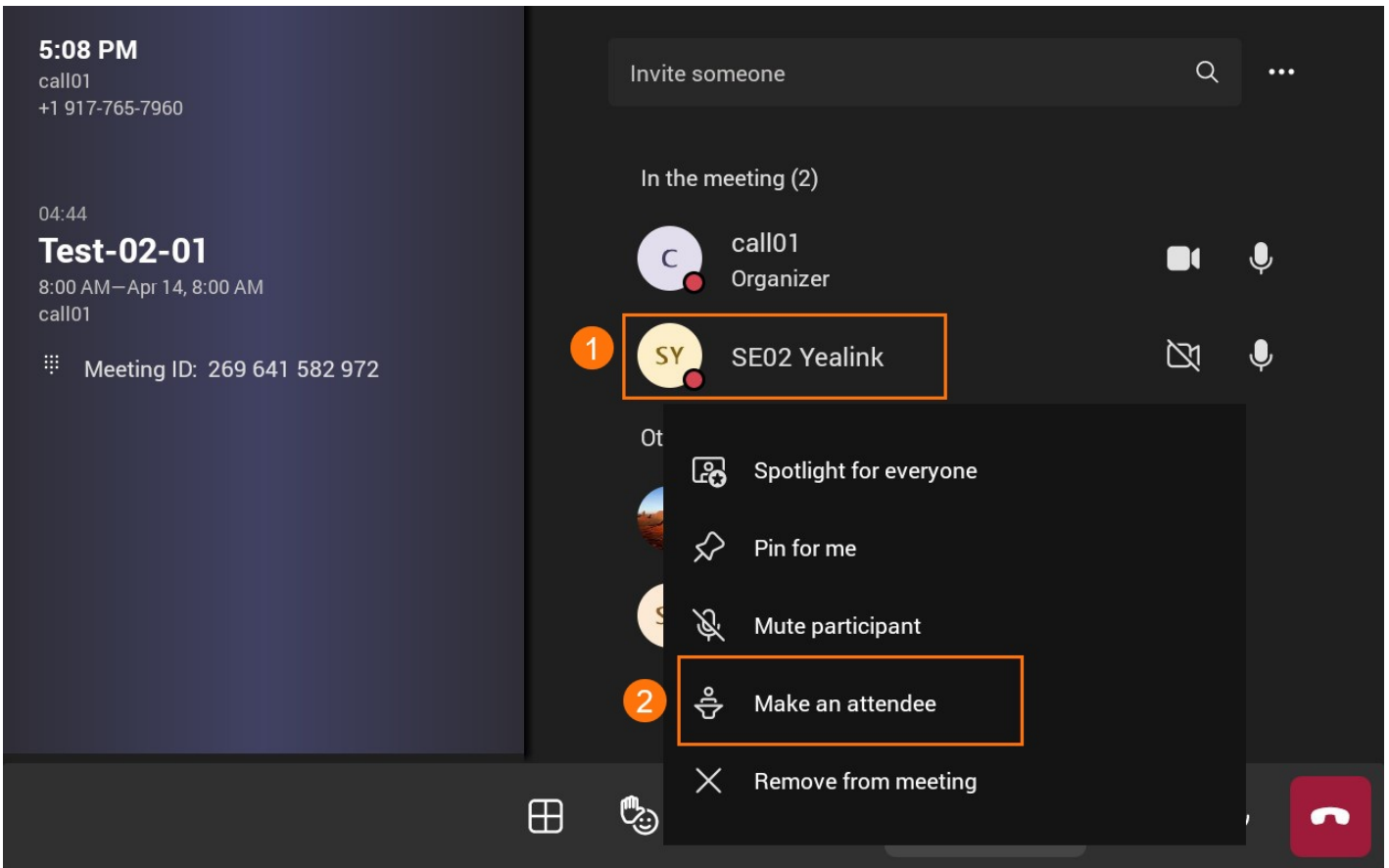

Manage Audio

Introduction

You can control the local volume and microphone or mute (MeetingBar A10/MeetingBar A20/MeetingBar A30) participants.

For the latest Teams features, please refer to [What's new in Microsoft Teams](#).

Use via Remote Control

Adjust Speaker

Adjust the local meeting volume.



Enable/Disable Microphone

Enable or disable the local microphone.



Mute Participant

You can mute a participant's microphone, and only the participant can unmute their microphone.

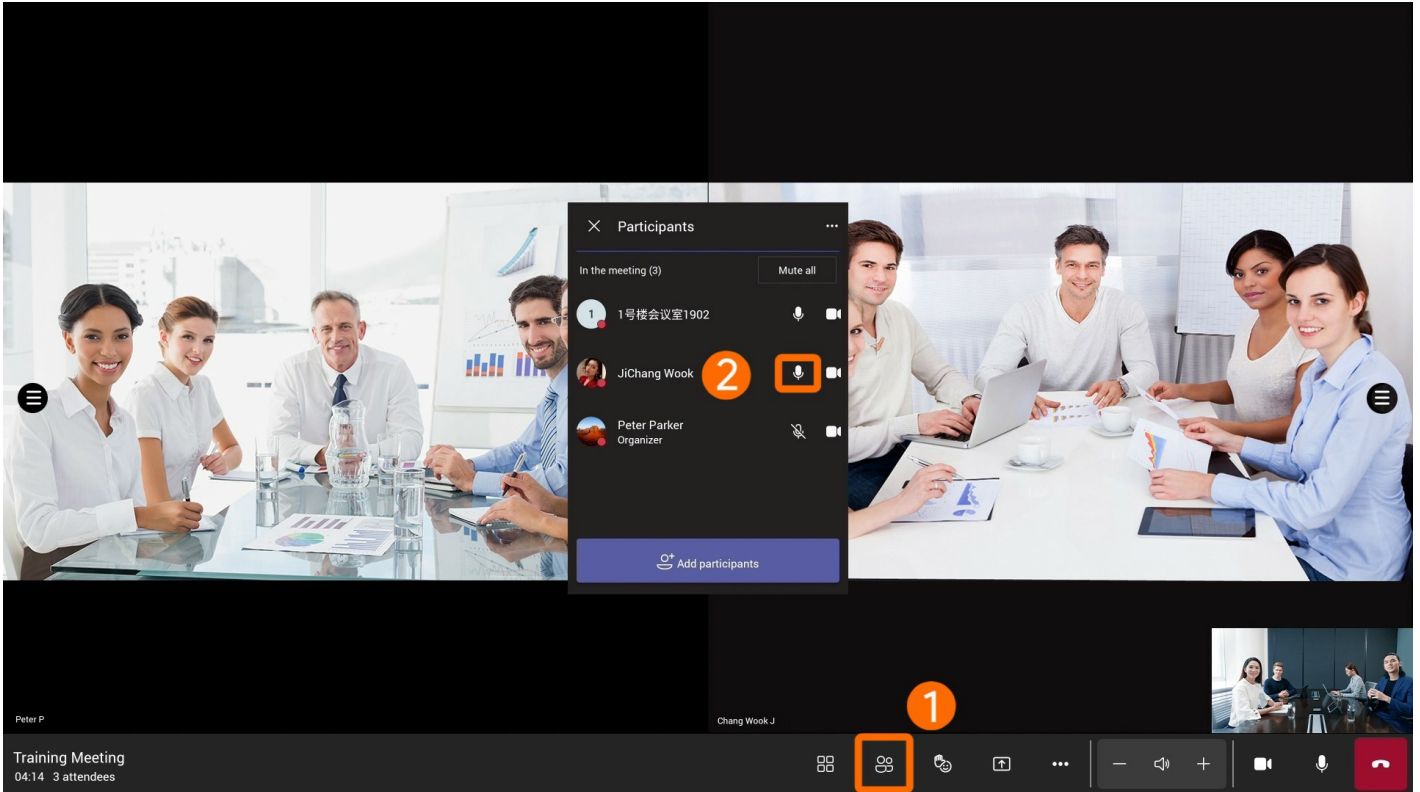

You can mute all participants' microphones, and only the participant can unmute their microphones.

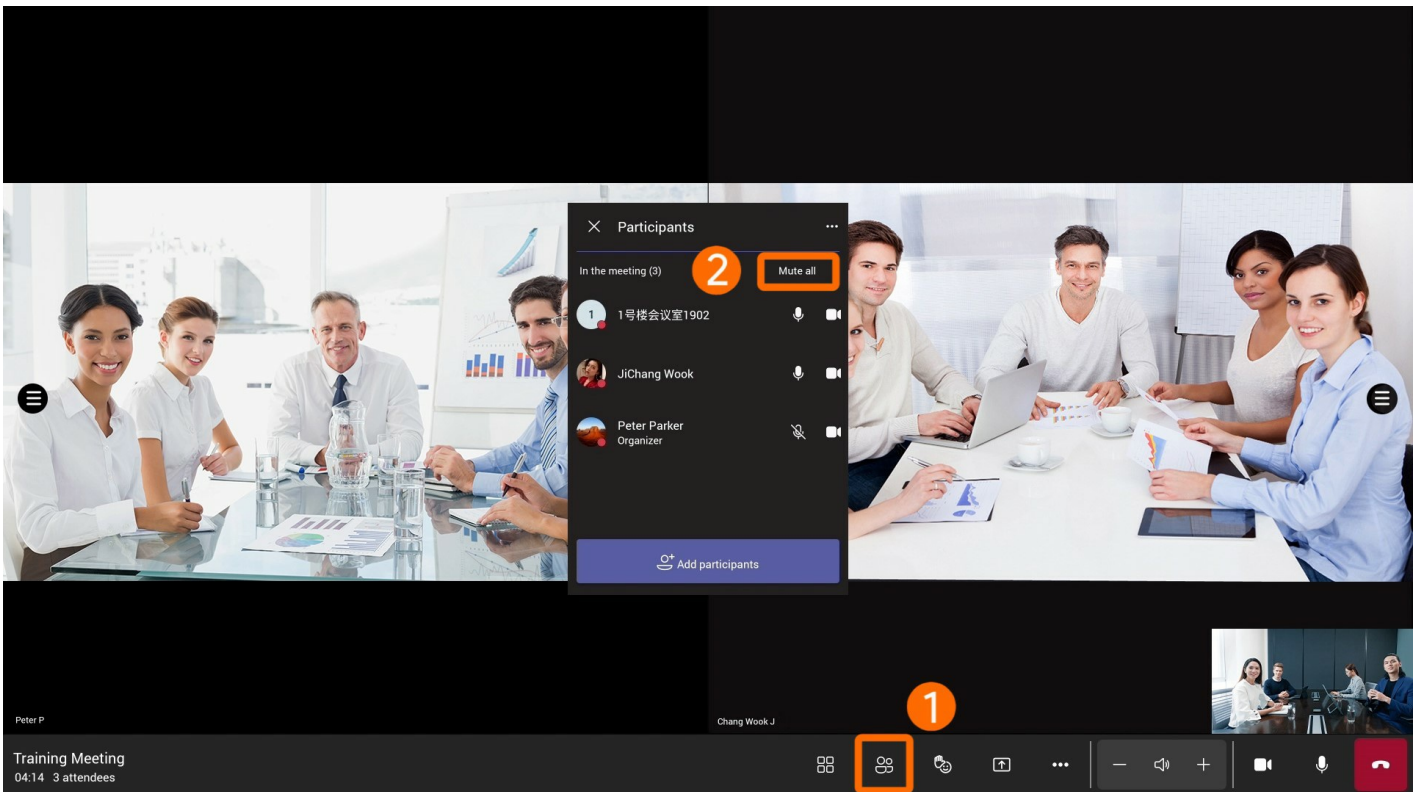

Disable/Enable Microphone for Participants

When you disable a **participant's** microphone, the participant can not use the microphone.

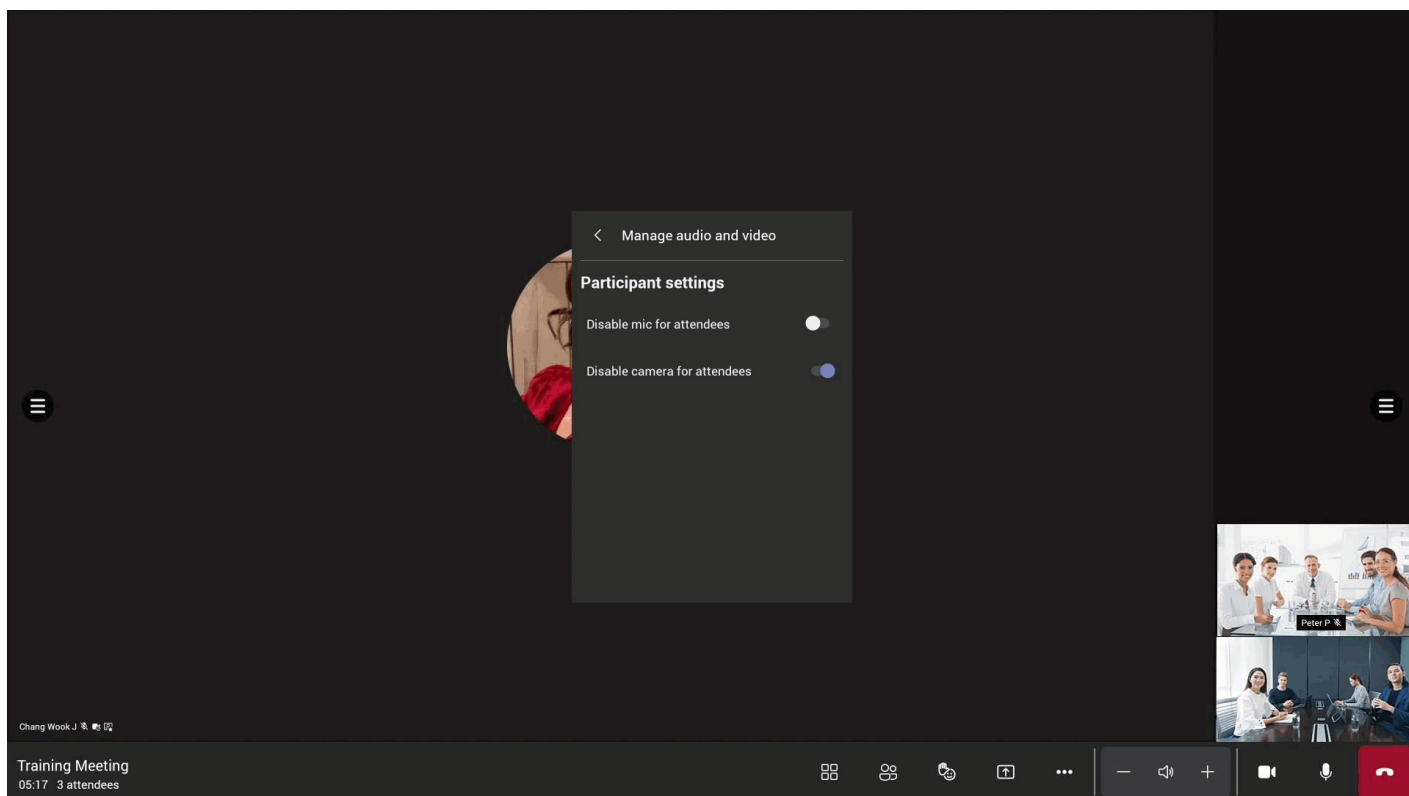

Use via CTP18 Control

Adjust Speaker

Adjust the local meeting volume.

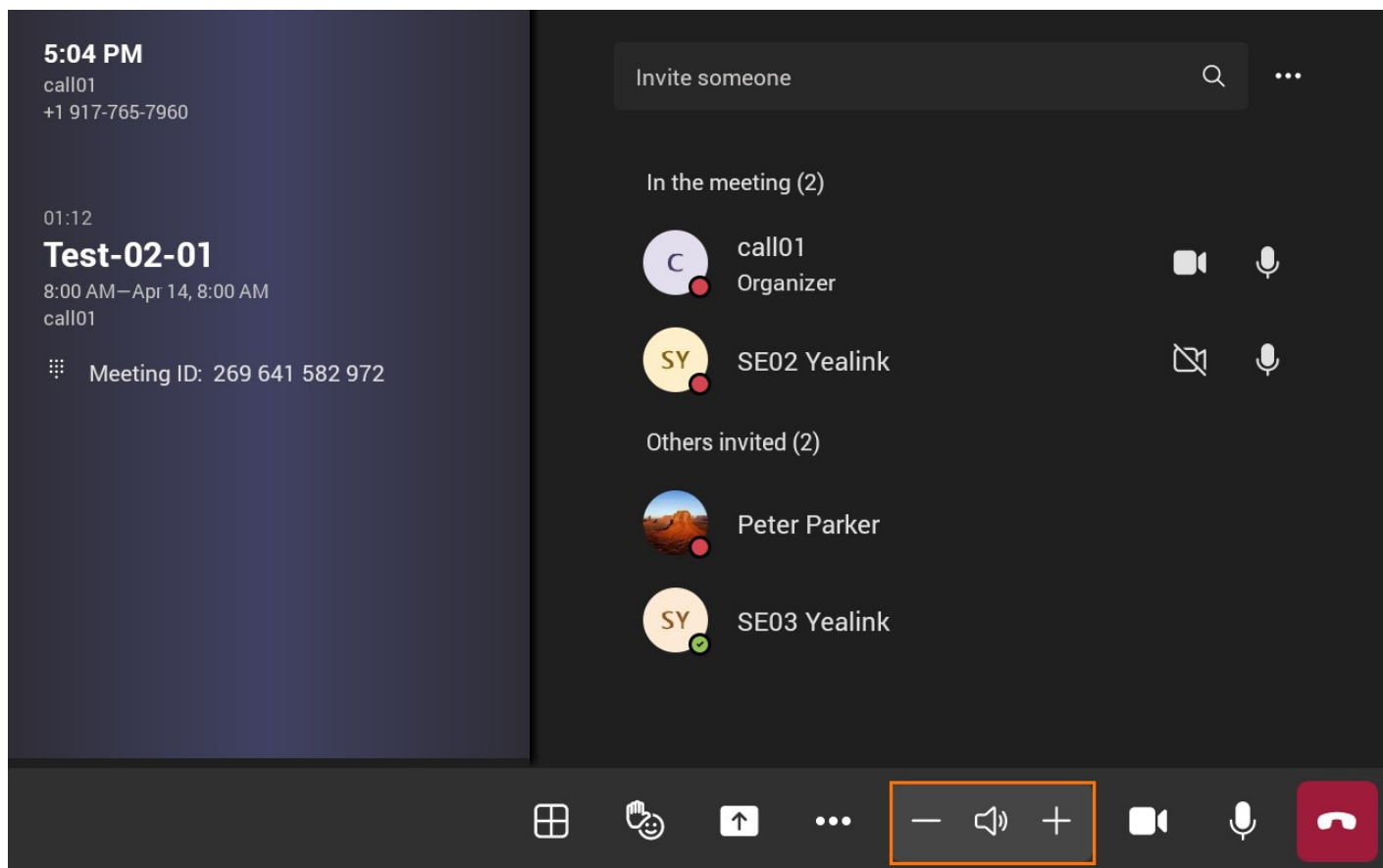

Enable/Disable Microphone

Enable or disable the local microphone.

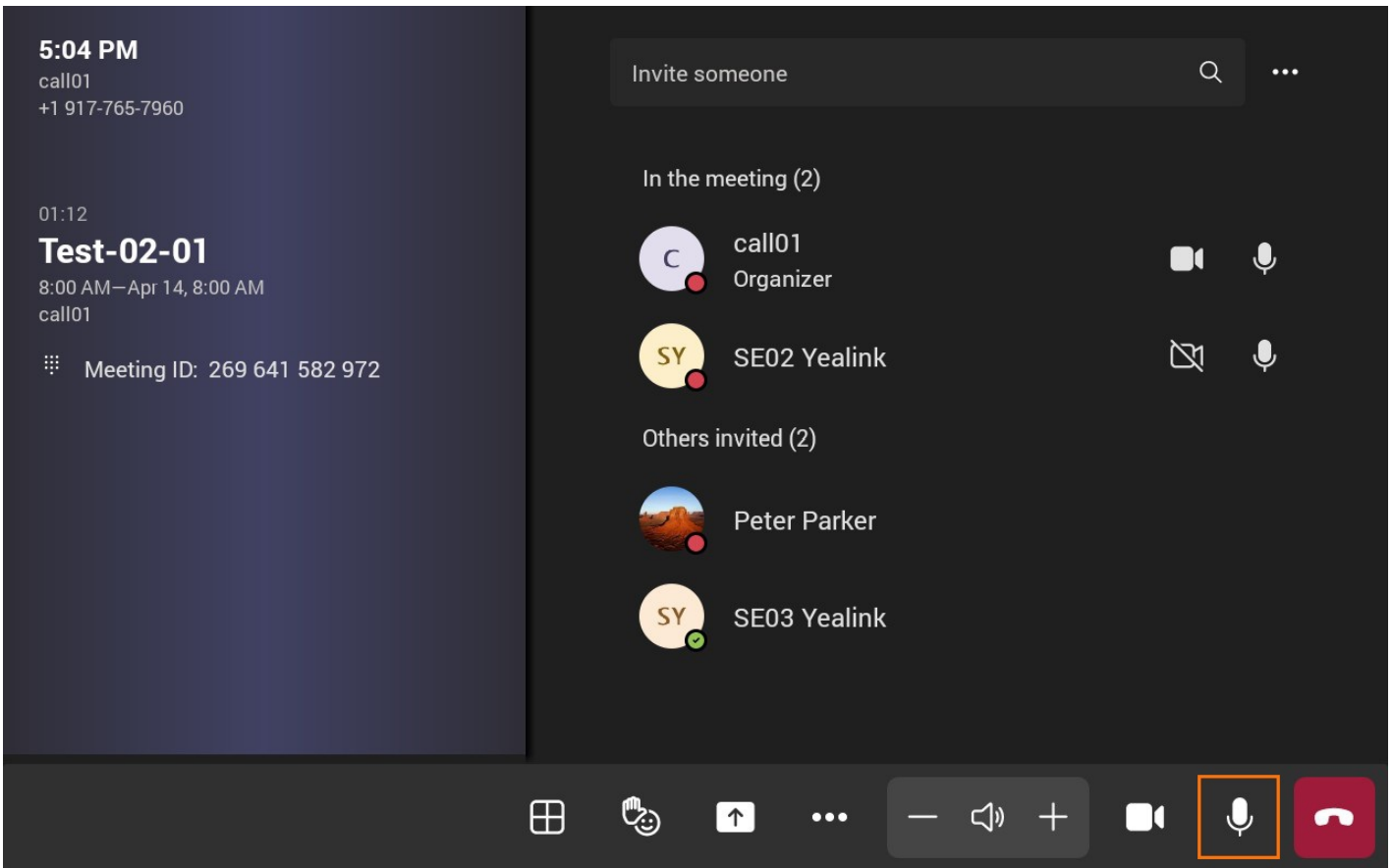

Mute Participant

You can mute a participant's microphone, and only the participant can unmute their microphones.

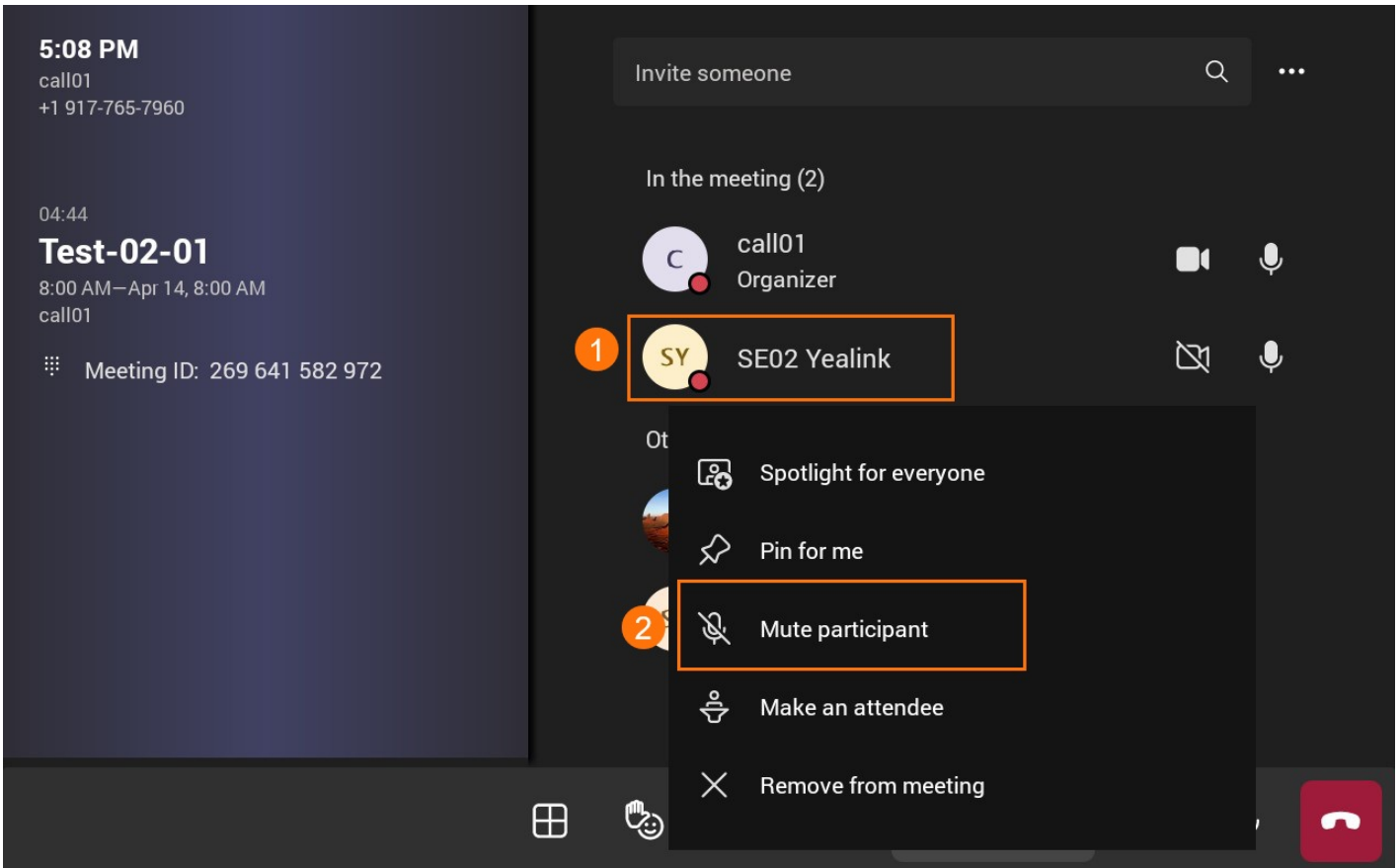

You can mute all participants' microphones, and only the participant can unmute their microphones.

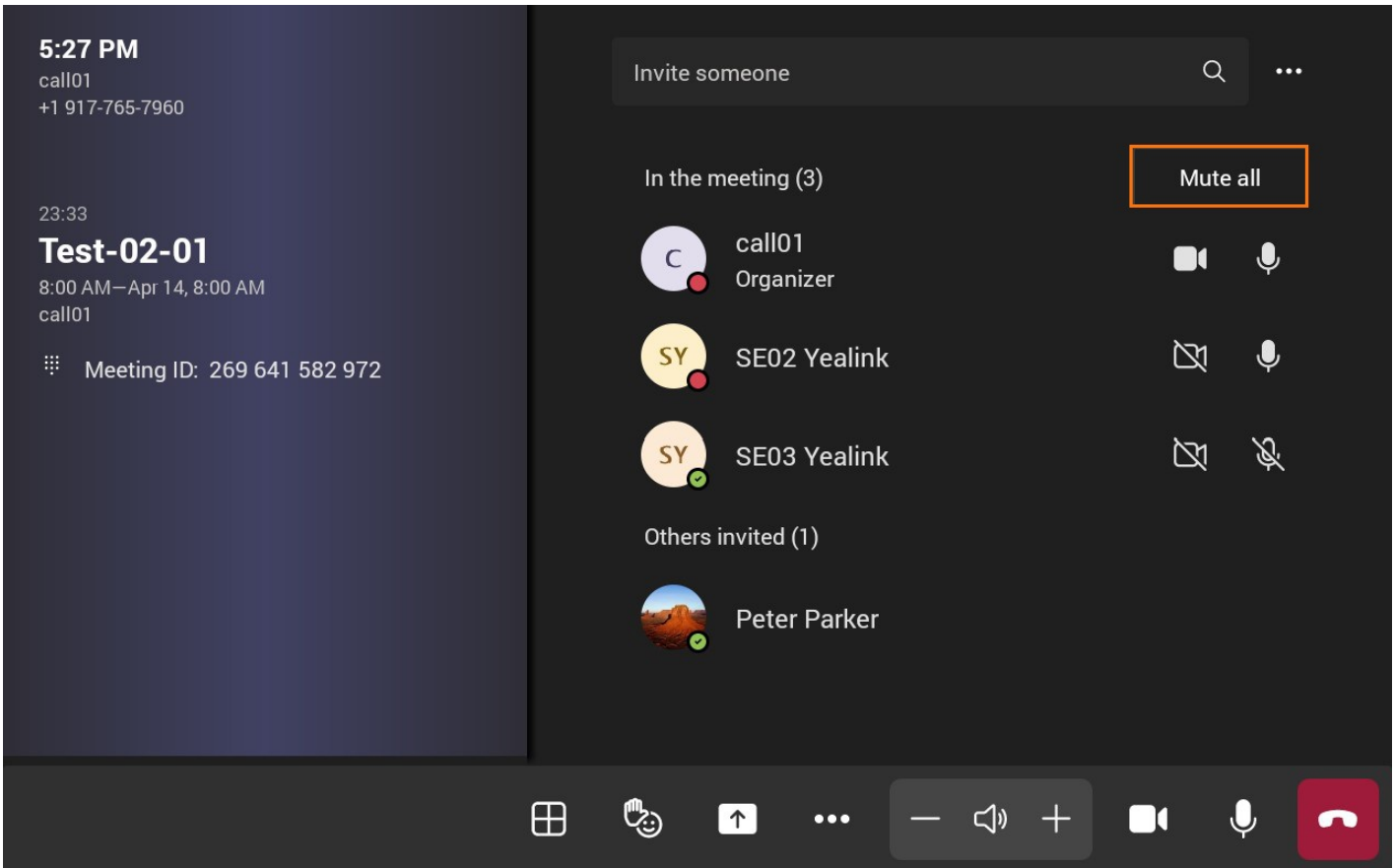

Disable/Enable Microphone for Participants

When you disable a **participant's** microphone, the participant can not use the microphone.

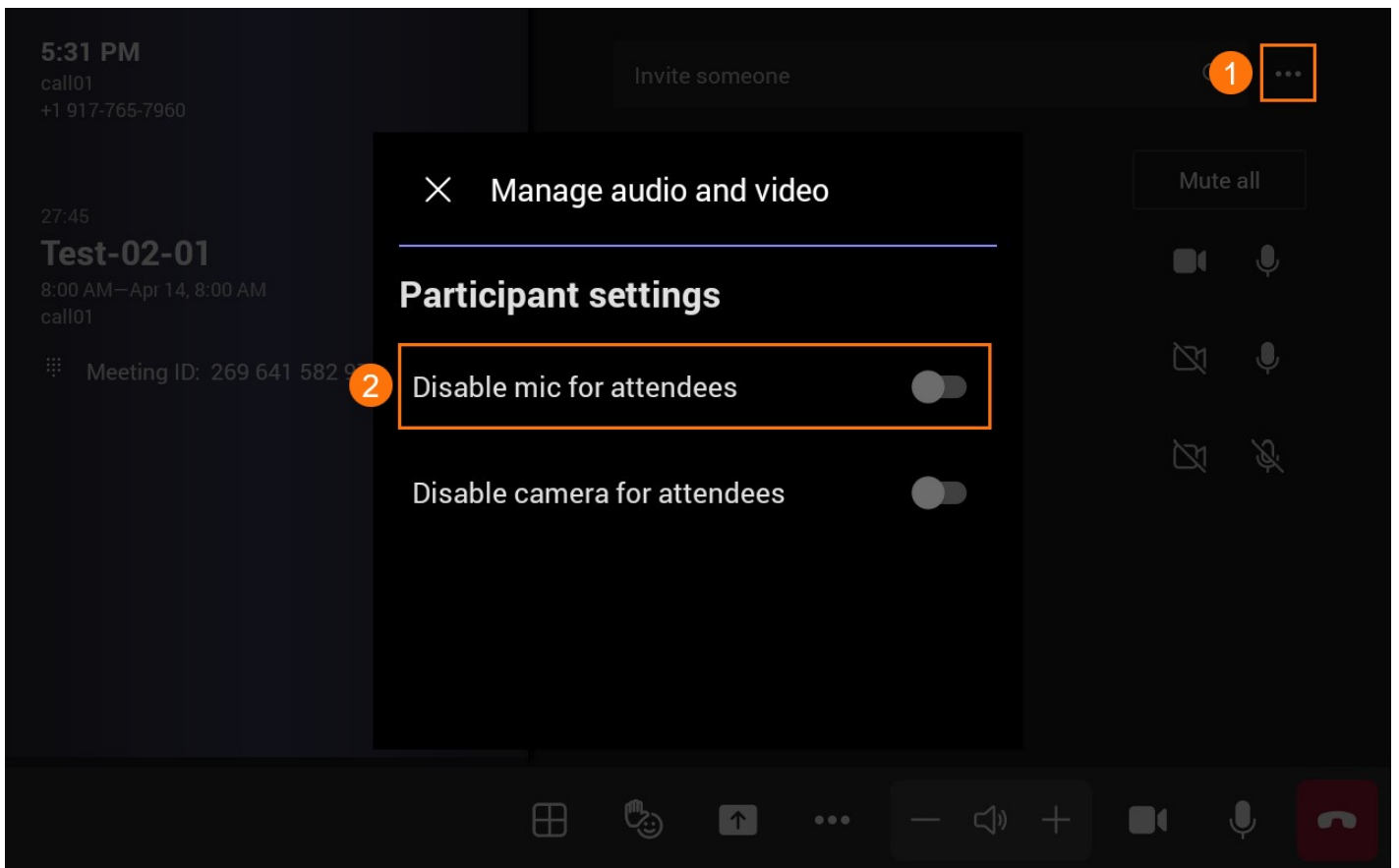

FAQ

Why is the volume of other parties loud and low intermittently?

Why cannot the other party hear my voice?

Check if the microphone is enabled. If the microphone is enabled, please contact your system administrator to resolve it.

Manage Video

Introduction

You can enable/Disable the local camera or the remote party's video screen. For the latest Teams features, please refer to [What's new in Microsoft Teams](#).

Use via Remote Control

Enable/Disable Local Camera

If you disable your camera, the remote party cannot see your video screen.



Enable/Disable A20 Incoming Video

If you disable your incoming video, you cannot see the video screen of the remote party.



Enable/Disable Participant Camera

If you disable a participant's camera, they will not be able to enable it.



Use via CTP18 Control

Enable/Disable Local Camera

If you disable your camera, the remote party cannot see your video screen.

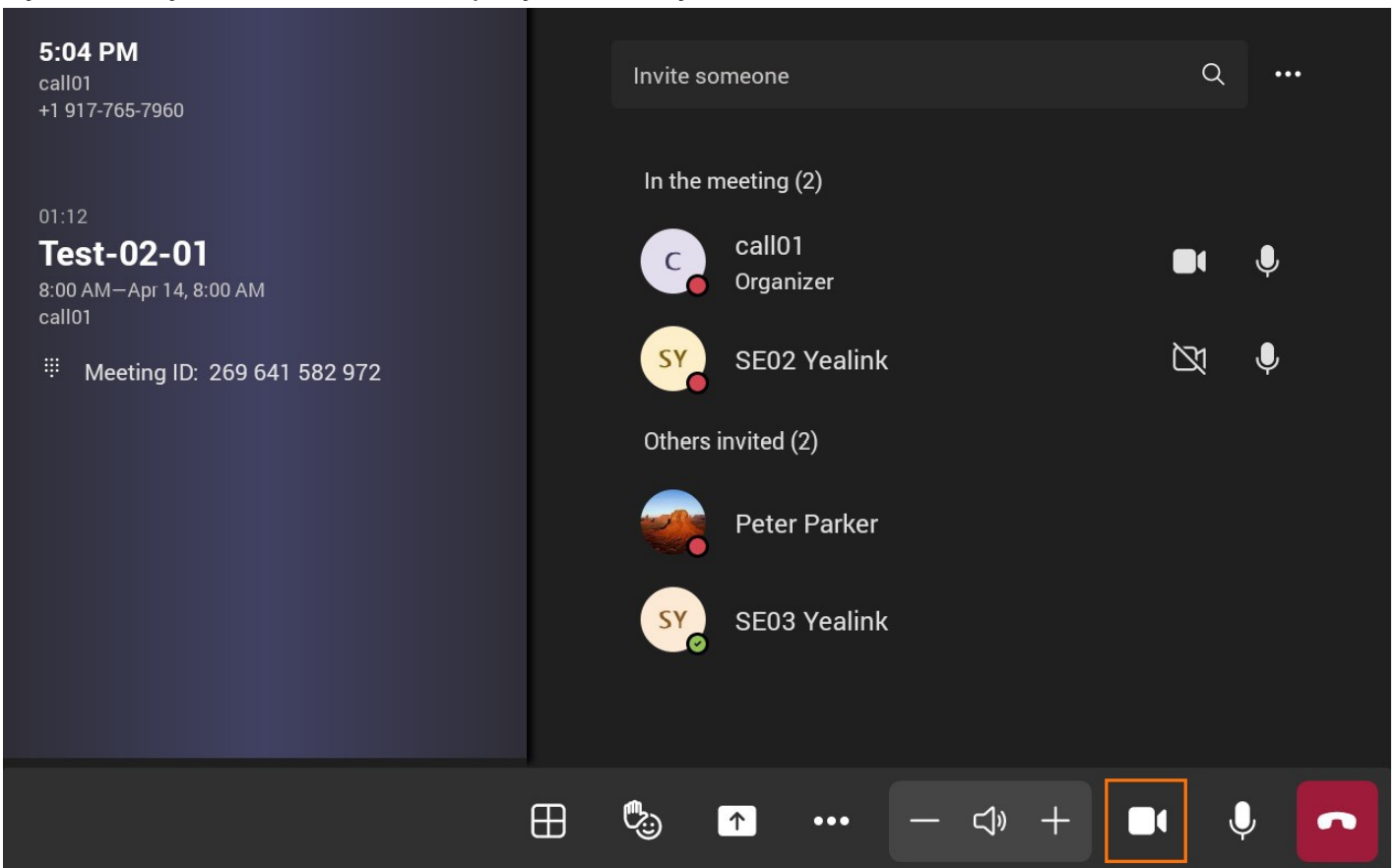

Enable/Disable Incoming Video

If you disable your incoming video, you cannot see the video screen of the remote party.

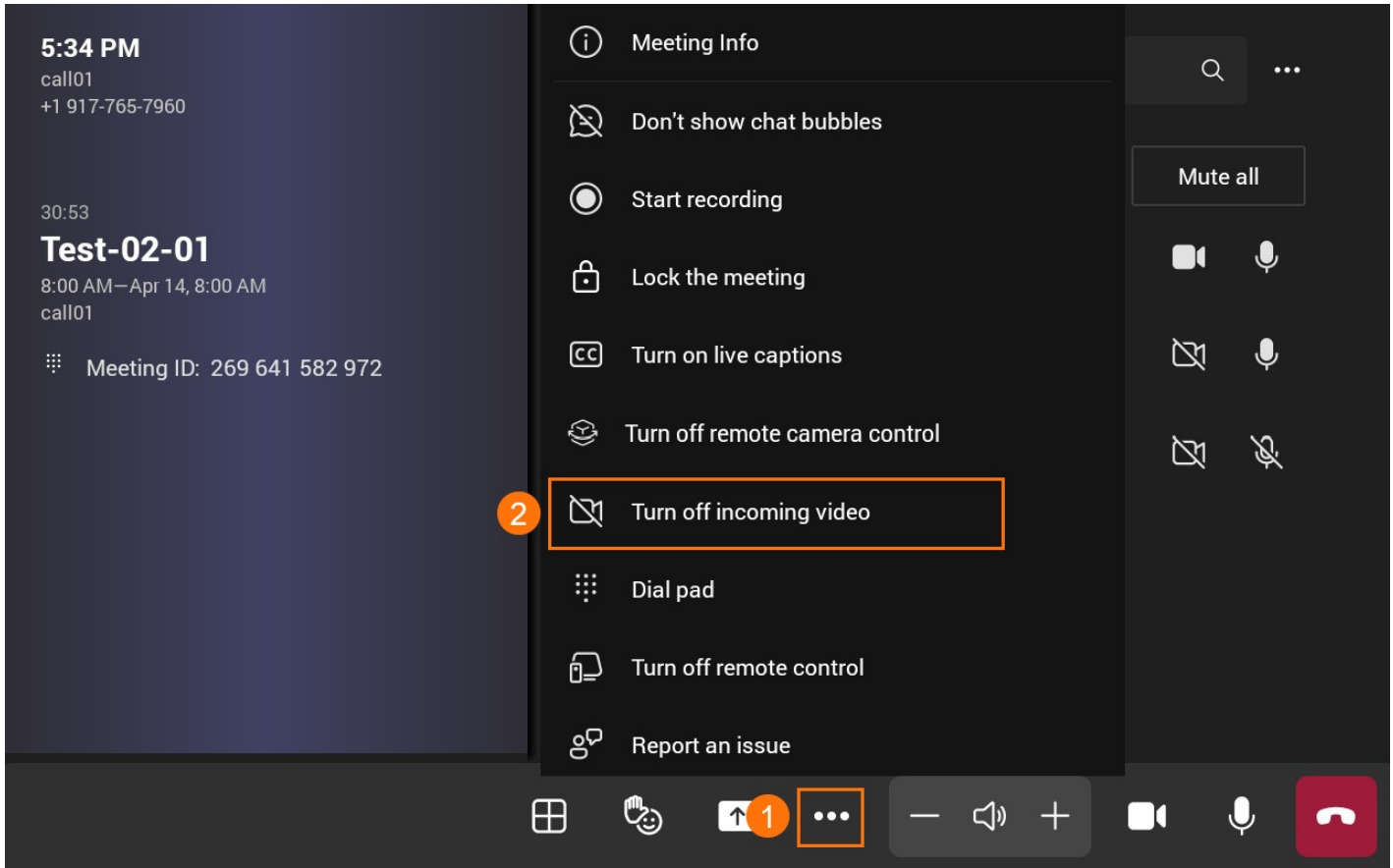

Enable/Disable Participant Camera

If you disable a participant's camera, they will not be able to enable it.

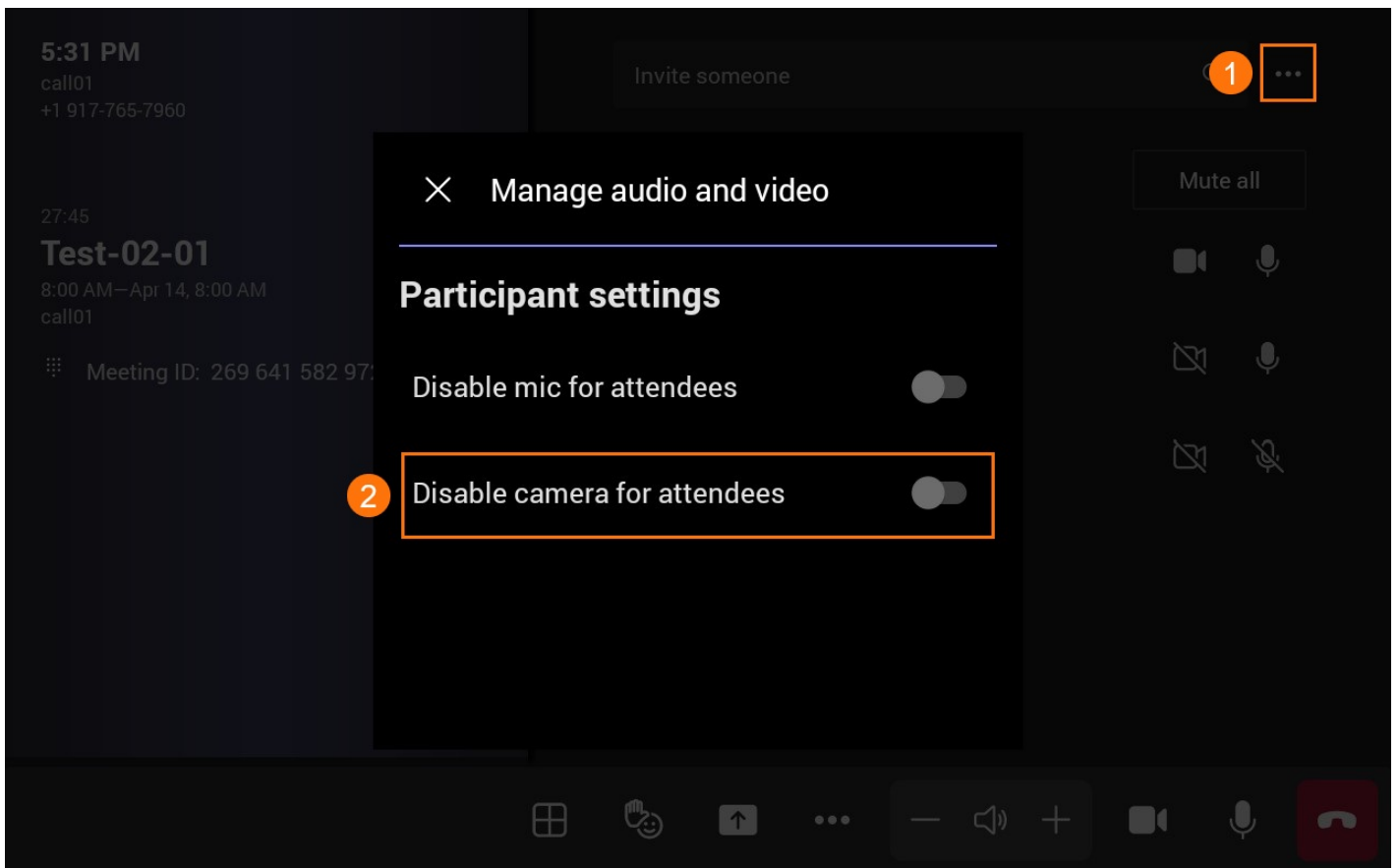

FAQ

What should I do if the remote video screen of the MeetingBar A20/A30 is black?

Does it support manually controlling the built-in camera?

Yes, you can [manually control](#) the camera before the meeting.

On the CTP18, tap **More** > **Settings** > **Device Settings** > **Camera Settings** > **Control** to adjust the camera.

Why can't I see the video image of the remote party?

In the meeting, tap **More** > go to **Turn on/off the incoming call** to check whether the incoming video is disabled.

Please contact your system administrator to resolve it if it is enabled.

Meeting Layout

Introduction

You can switch between gallery view, large gallery view and together mode.

For the latest Teams features, please refer to [What's new in Microsoft Teams](#).

Use via Remote Control

Gallery

Displays the default view of the 3 x 3 video layout when joining a meeting.



Large Gallery

Displays the default view of the 7 x 7 video layout when joining a meeting.

NOTE
10 people must have their cameras turned on. If no one's sharing a video, a Large gallery cannot be selected from the menu.



Together Mode

A layout that shows you are in the same background as everyone in the meeting.

NOTE
Together mode is available if there are at least five people in a meeting.

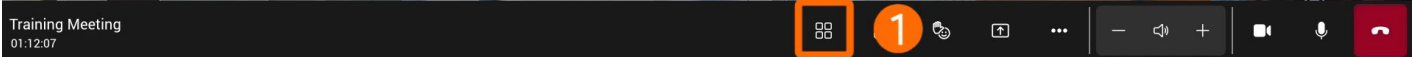

Use via CTP18 Control

Gallery

Displays the default view of the 3 x 3 video layout when joining a meeting.

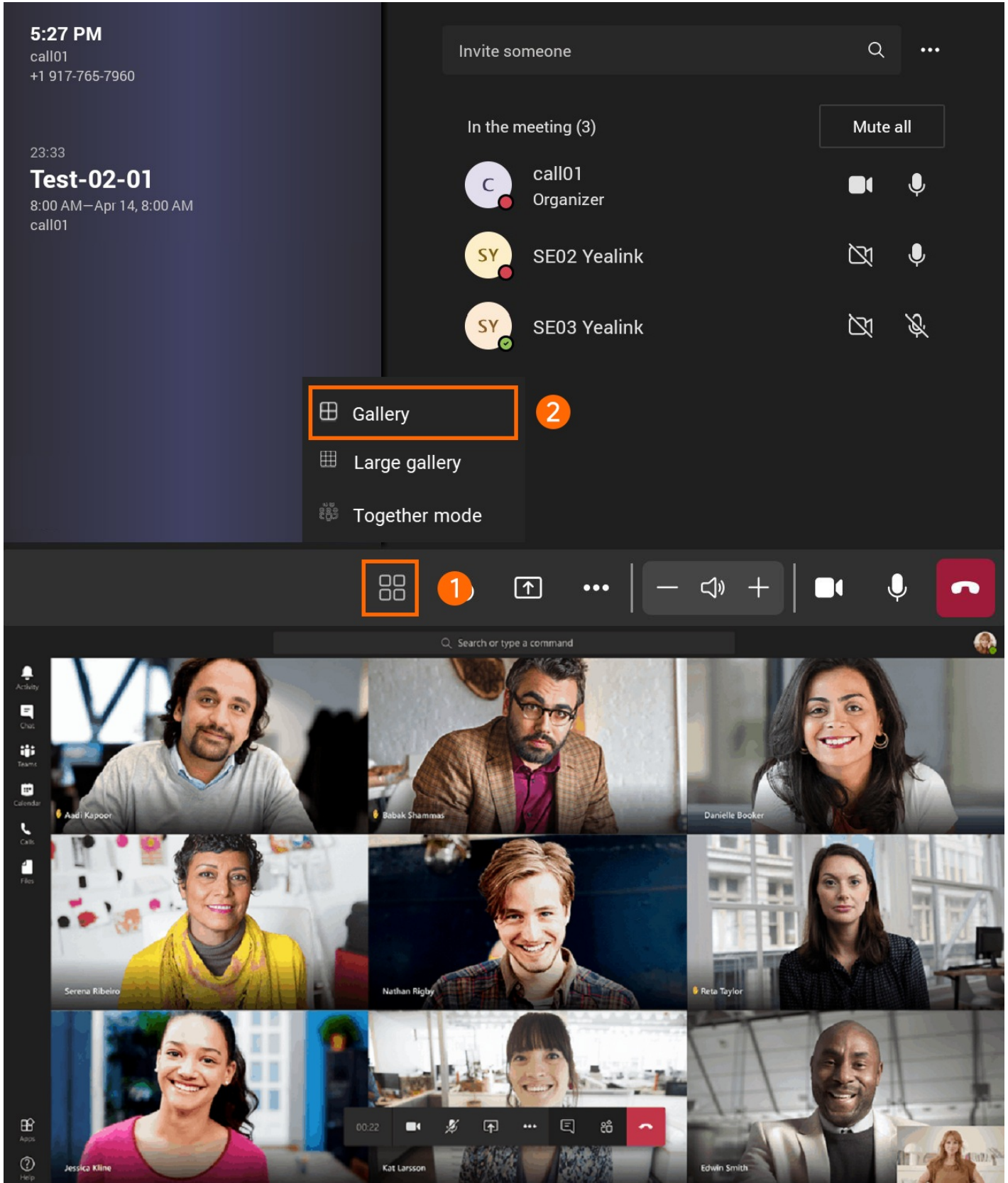

Large Gallery

Displays the default view of the 7 x 7 video layout when joining a meeting.

NOTE
10 people must have their cameras turned on. If no one's sharing a video, a Large gallery cannot be selected from the menu.

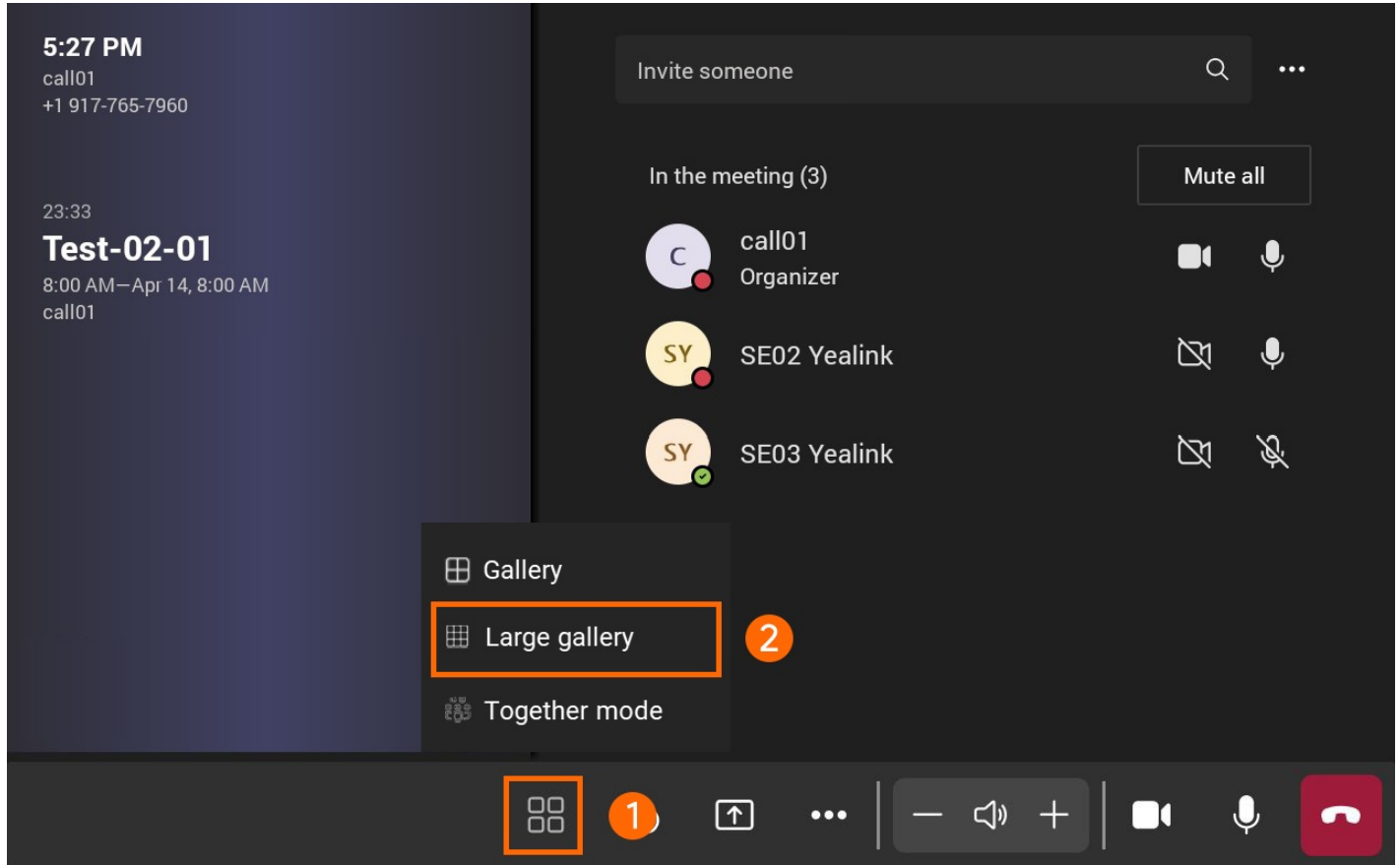



Together Mode

A layout that shows you are in the same background as everyone in the meeting.

NOTE
Together mode is available if there are at least five people in a meeting.

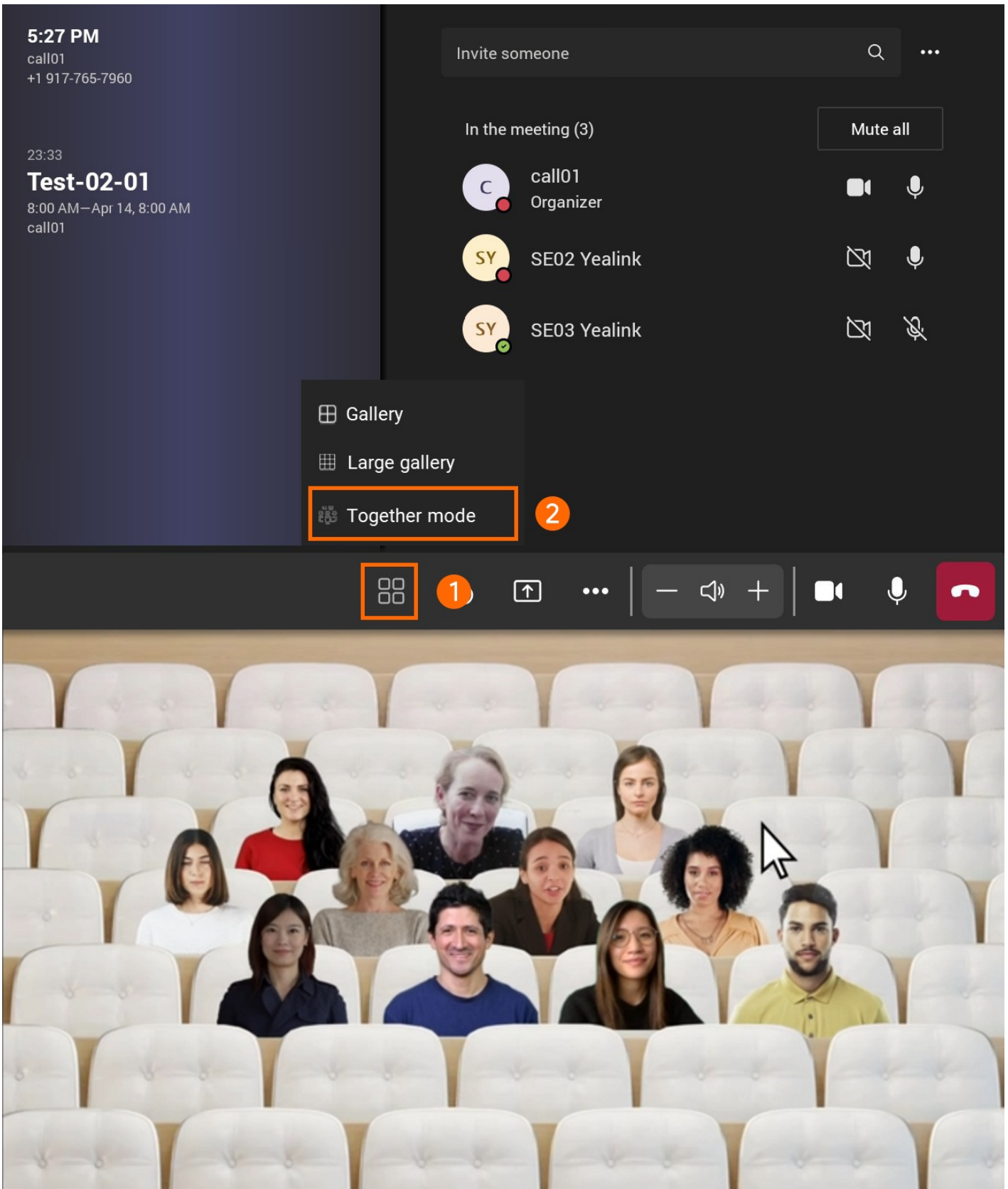

FAQ

There are no options for Large Gallery and Together Mode in the meeting.

- 10 people must have their cameras turned on. If no one's sharing a video, a Large gallery cannot be selected from the menu.
- Together mode is available if there are at least five people in a meeting.

Meeting Control

Introduction

You can use more meeting control in the MeetingBar A10/A20/A30 meeting. For the latest Teams features, please refer to [What's new in Microsoft Teams](#).

Use via Remote Control

Change Meeting Background

You can replace the meeting background with a different image.



Record Meeting

NOTE

- The recorded meeting file is saved to OneDrive SharePoint.
- The Whiteboard content will not be recorded.



Enable Share Whiteboard

MeetingBar AX0 133.15.0.52 and later firmware versions support whiteboard sharing in meetings. For more information on the whiteboard, please refer to [Whiteboard](#). For the firmware version, please refer to [Release Note](#).

NOTE

- The shared whiteboard is not available for instant meetings.
- After the MeetingBar AX0 is correctly connected to the touch display, you can use the whiteboard function: connect to the HDMI port to input video and audio signals, and connect to the USB-A port to input touch signals.
- It does not support two people writing on the local whiteboard simultaneously.

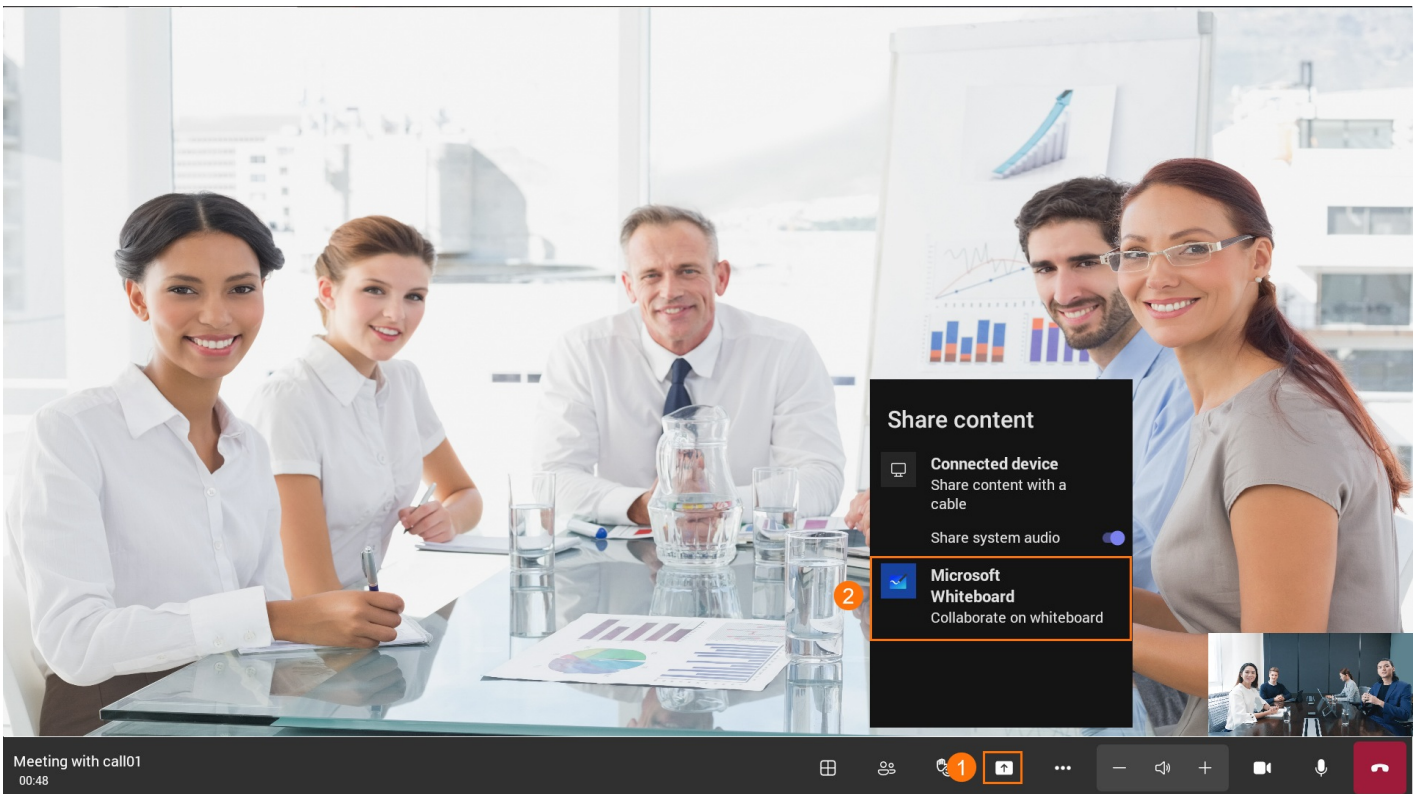

You can use brushes, erase, text, and sticky notes on the whiteboard during a meeting.

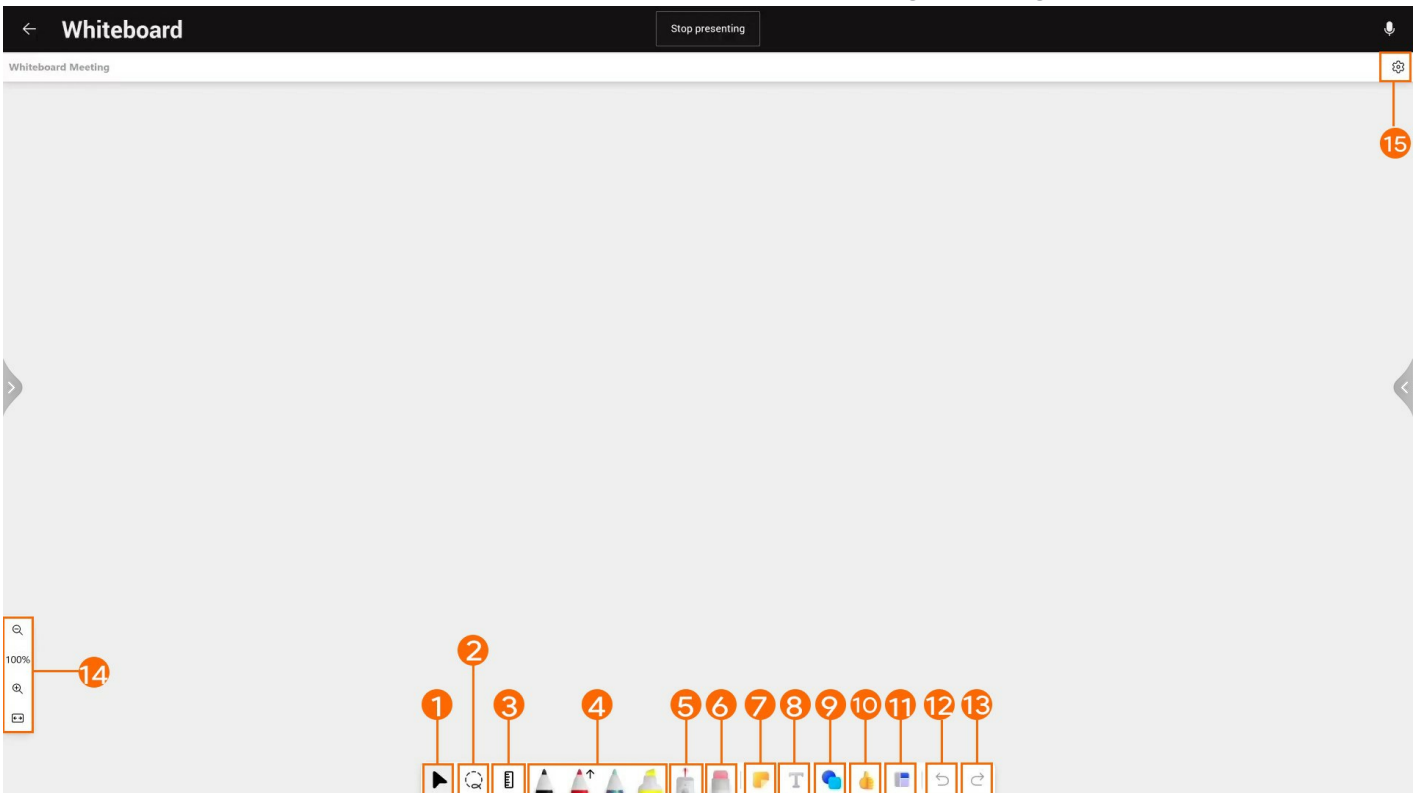

No.	Description
1	Move/zoom in/out of the whiteboard.
2	Use to circle content. After circling, you can move/copy/delete or zoom in/zoom out the content.
3	Ruler: draw straight lines at different angles.

4	Brushes/highlighters
5	Laser point: use it to indicate the content.
6	Eraser: erase the content.
7	Stickys
8	Text
9	Shape
10	Emojis
11	Template
12	Undo
13	Redo
14	Zoom the whiteboard
15	Whiteboard setting

Enable/Disable Live Caption

Convert real-time speech to subtitles, which currently only support English.

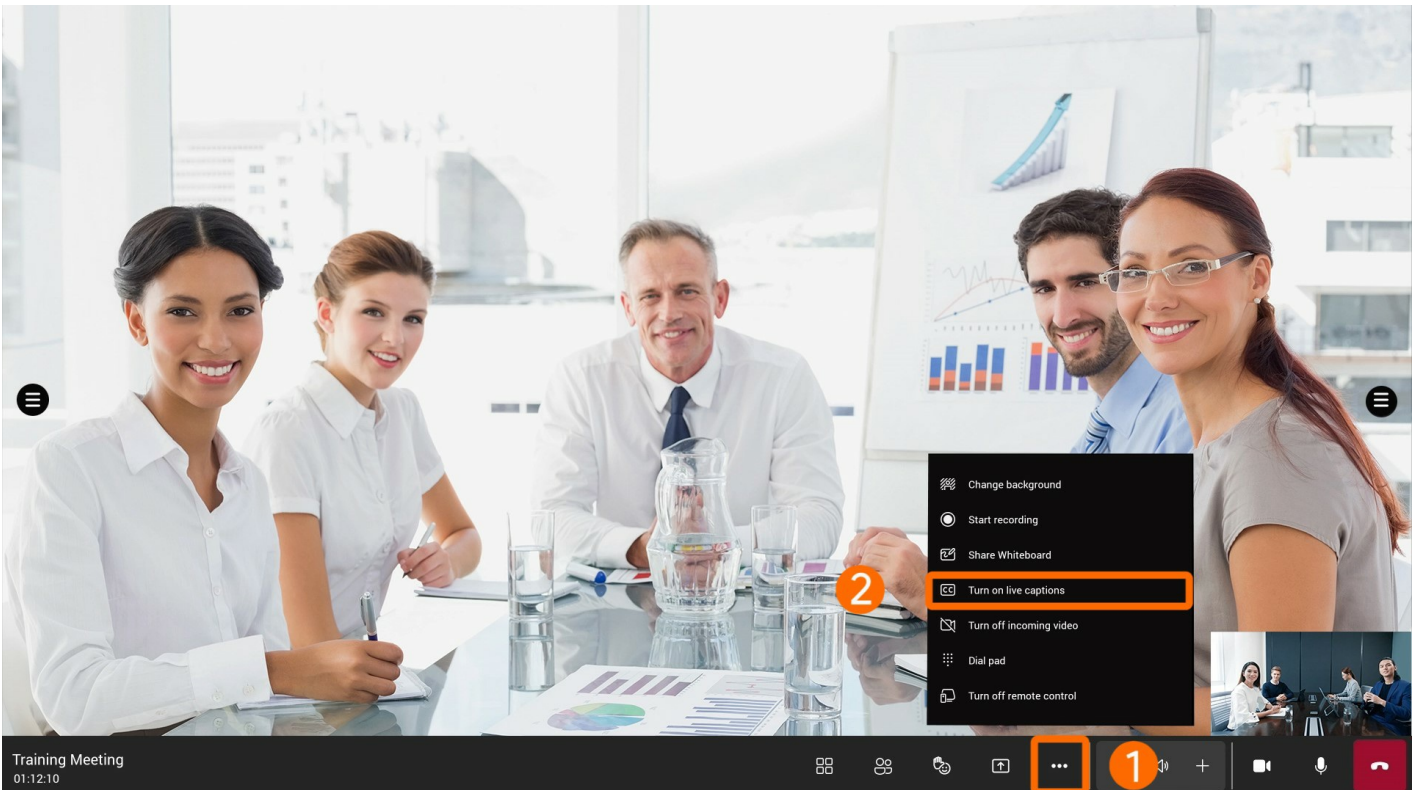

Enable/Disable Remote Control

Enable or disable the feature of controlling the conference room system on mobile devices.



When starting meetings on the mobile client, you can control the relevant features of the meeting room: video, audio, subtitles, screen layout, etc.

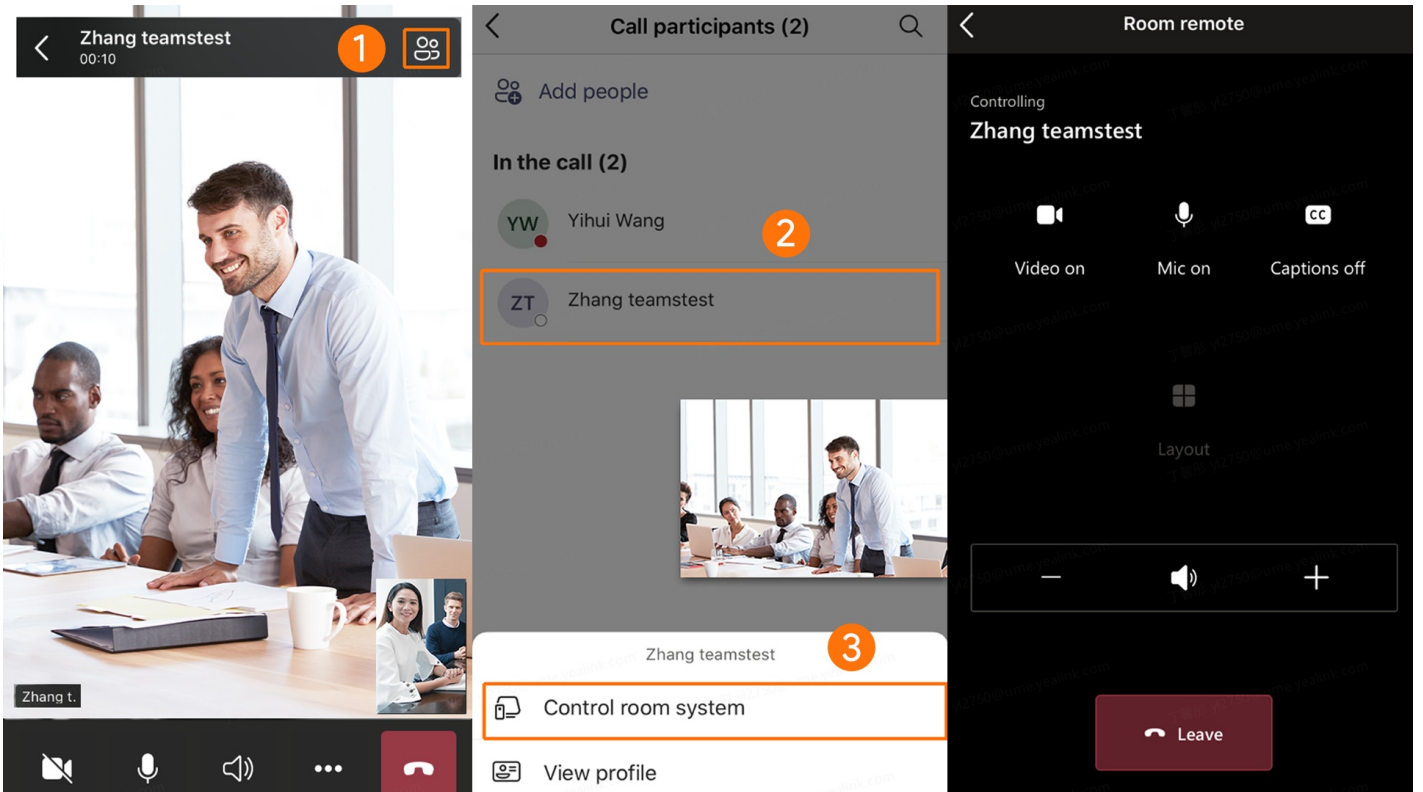

Use via CTP18 Control

Record Meeting

NOTE

- The recorded meeting file is saved to the OneDrive SharePoint.
- The Whiteboard content will not be recorded.

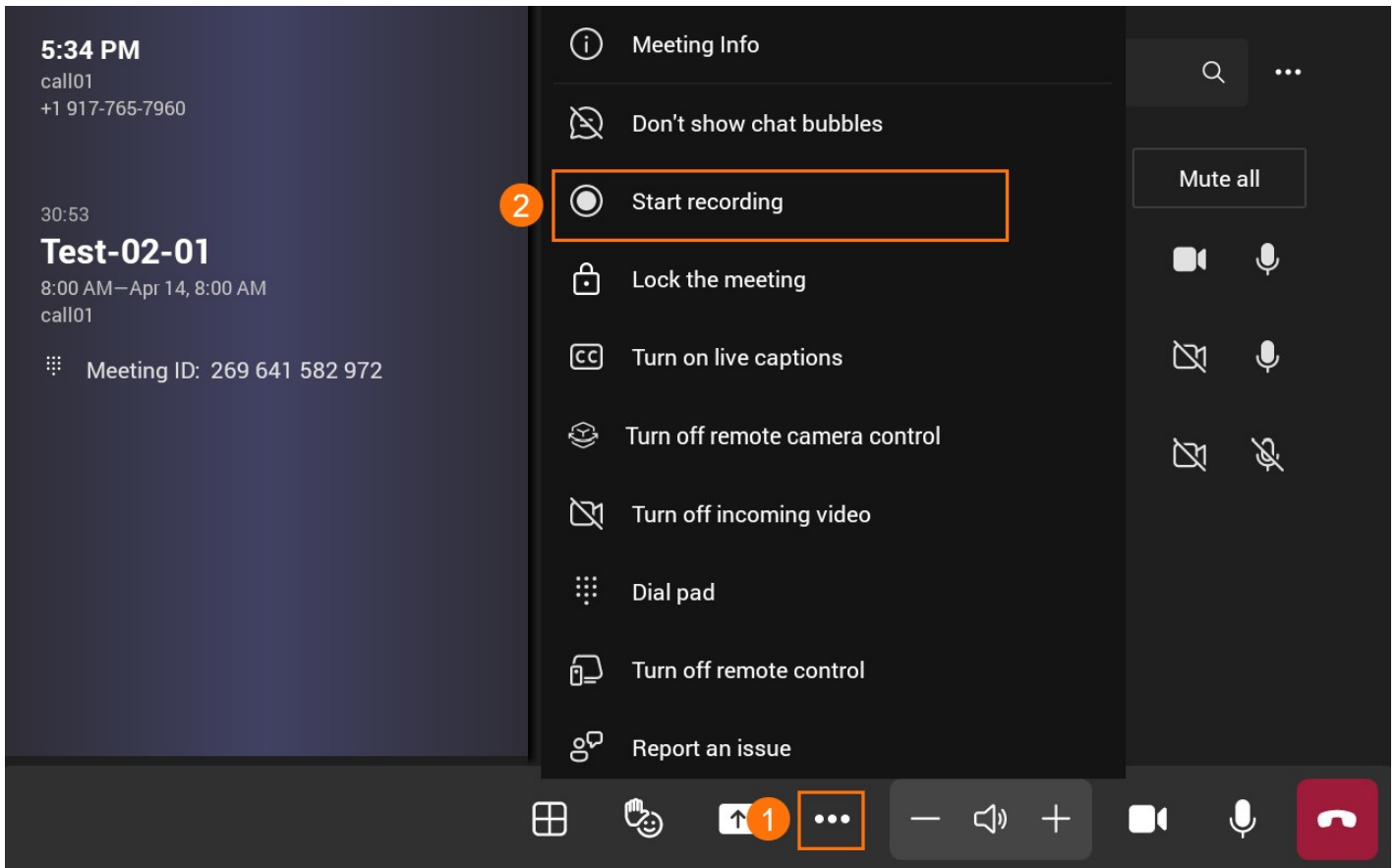
**Enable Share Whiteboard**

MeetingBar AX0 133.15.0.52 and later firmware versions support whiteboard sharing in meetings. For more information on the whiteboard, please refer to [Whiteboard](\03. MeetingBoard 65_86\05. User Manual\02. Whiteboard). For the firmware version, please refer to [Release Note](#).

NOTE

- The shared whiteboard is not available for instant meetings.
- After the MeetingBar AX0 is correctly connected to the touch display, you can use the whiteboard feature: connect to the HDMI port to input video and audio signals, and connect to the USB-A port to input touch signals.
- The multi-person for local whiteboard writing is not supported.

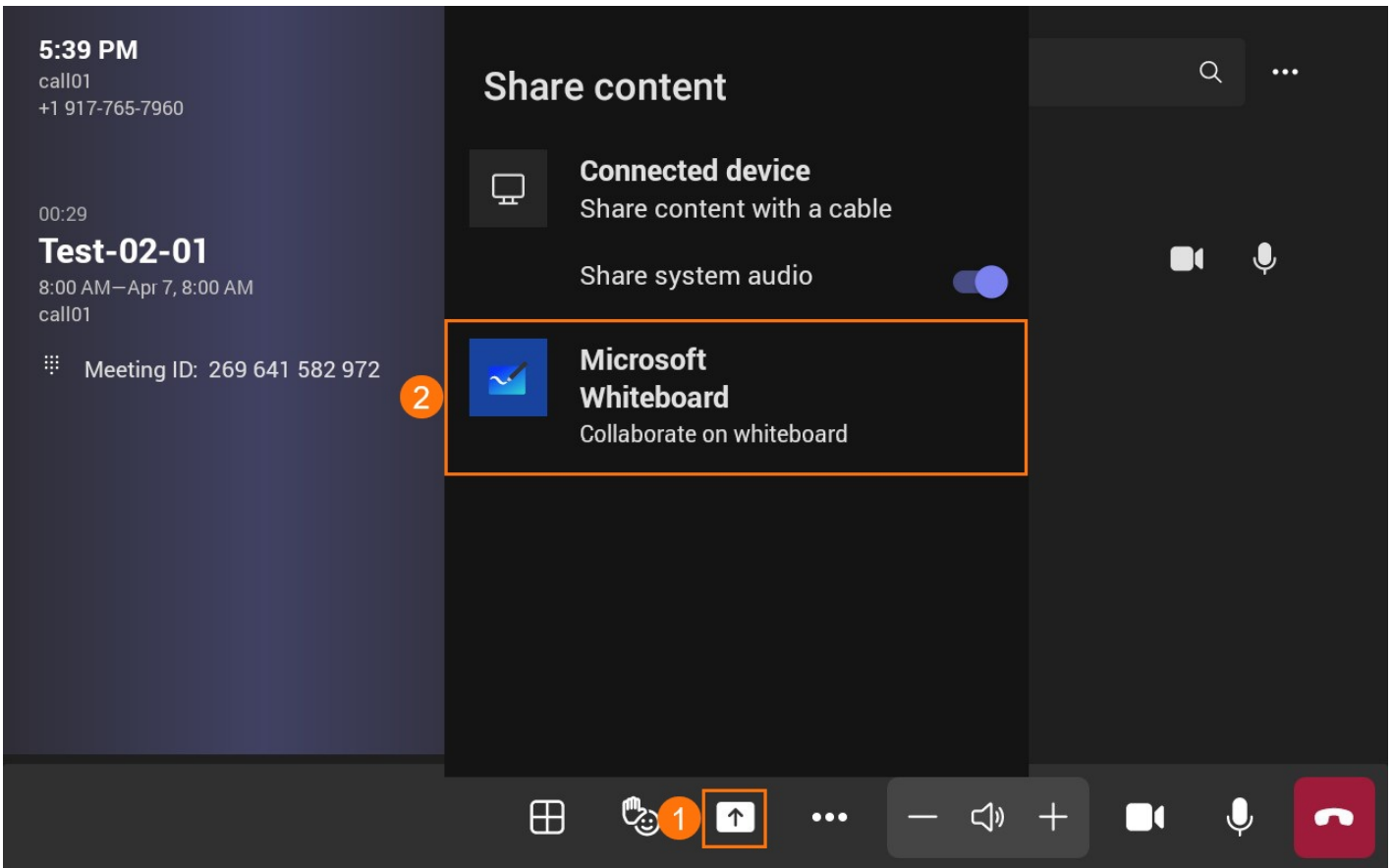

You can use brushes, erase, text, and sticky s on the whiteboard during a meeting.

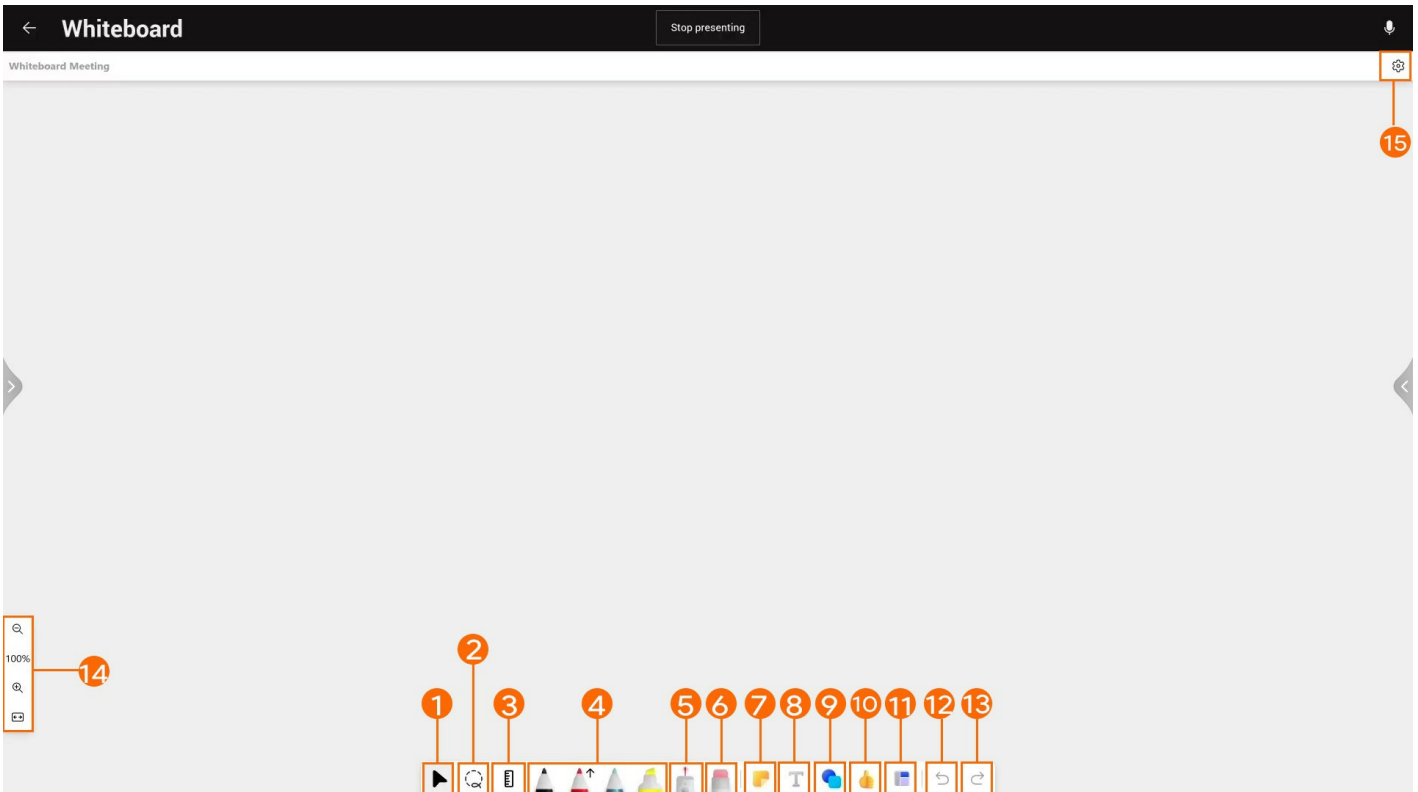

No.	Description
1	Move/zoom in/out of the whiteboard.
2	Use to circle content. After circling, you can move/copy/delete or zoom in/zoom out the content.

3	Ruler: draw straight lines at different angles.
4	Brushes/highlighters
5	Laser point: use it to indicate the content.
6	Eraser: erase the content.
7	Sticky s
8	Text
9	Shape
10	Emojis
11	Template
12	Undo
13	Redo
14	Zoom the whiteboard
15	Whiteboard setting

Enable/Disable Live Captive

Convert real-time speech to subtitles, which currently only support English.

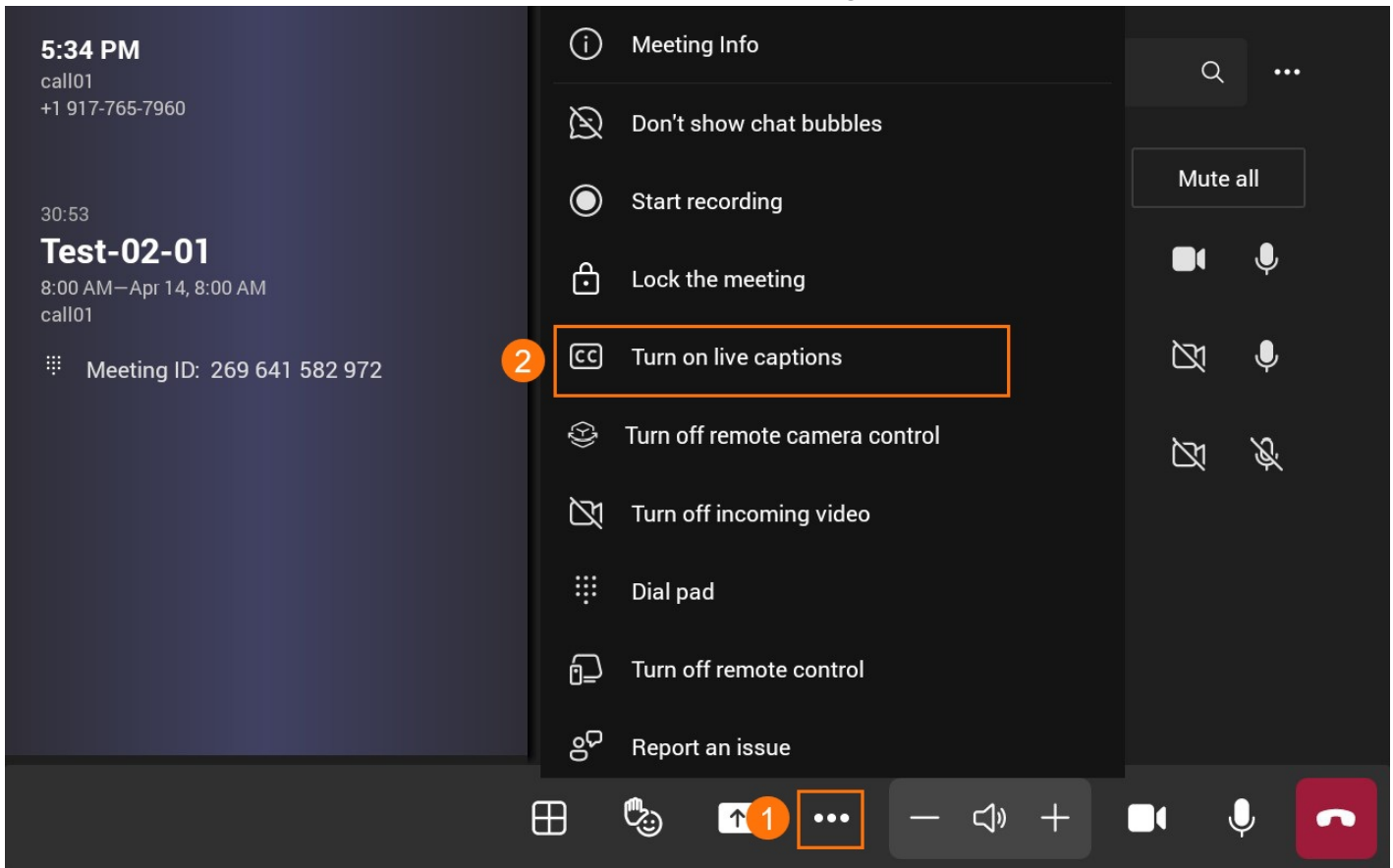

Enable/Disable Remote Control

Enable or disable the feature of controlling the meeting room system on the mobile client.

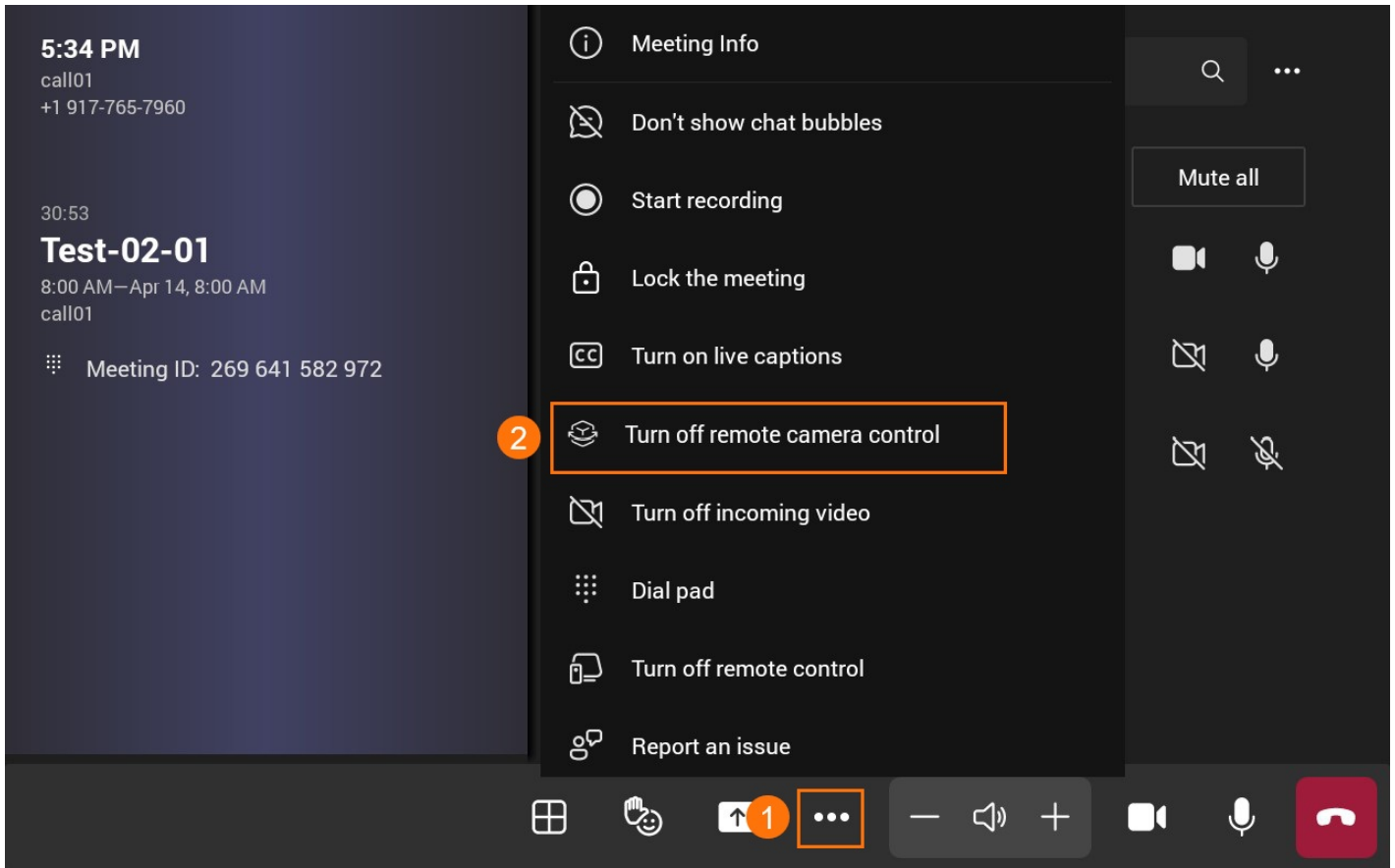

When meeting with the mobile client, you can control the relevant features of the meeting room: video, audio, subtitles, screen layout, etc.

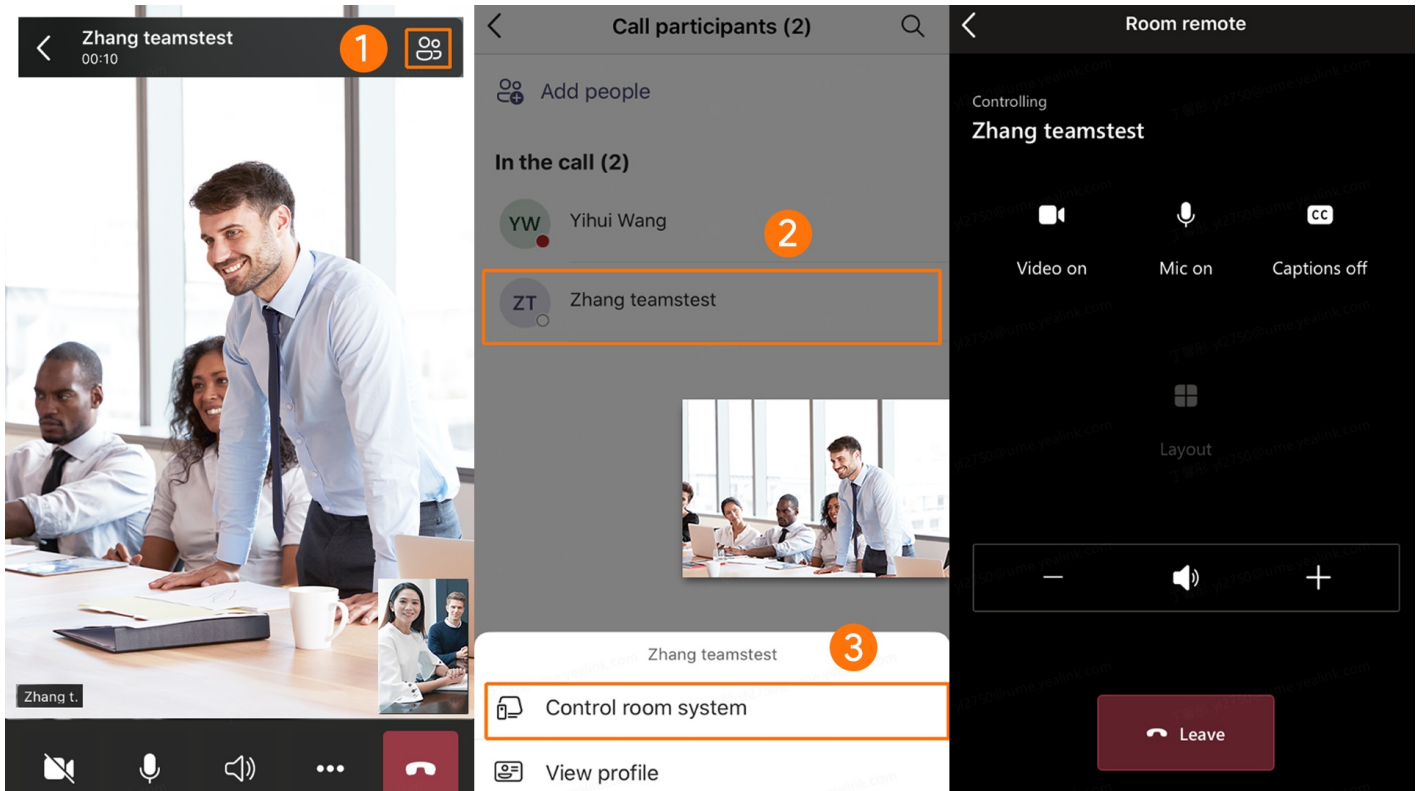

FAQ

Where are recorded meeting files saved?

The recorded meeting file is saved to the OneDrive SharePoint.rive SharePoint.

Content Sharing

Wireless Content Sharing

Introduction

Both MeetingBar A20 and MeetingBar A30 support content sharing with WPP20 and WPP30. The MeetingBar A10 only supports content sharing with WPP30.

MeetingBar A10/A20/A30 (hereinafter referred to as MeetingBar AX0) supports the content sharing feature in an idle state or a Teams meeting. You can share your desktop or running applications, and the resolution supports up to 1080p 30fps when sharing content.

MeetingBar AX0 can pair with up to 4 WPP20/WPP30 devices simultaneously, with only one device being used for content sharing at a time. In an idle state or a Teams meeting, only one content sharing is supported (including local and remote participants' content sharing).

If multiple screens are being shared simultaneously, the content of the previous content sharing will be replaced by the content of the later one (regardless of whether it is wired or wireless content sharing).

For the operation video, please refer to [Content Sharing](#).

WPP20/WPP30 Compatibility

For the WPP20/WPP30 compatibility, please refer to [Teams Room Accessories Compatibility Lists](#).

LED Status

For more information, please refer to [WPP20](#) or [WPP30](#).

Before You Begin

- You need to log in to your Microsoft Teams account in MeetingBar AX0.
- Before using CTP18 to operate MeetingBar AX0, the two devices need to be paired.
- WPP20/WPP30 supports content sharing on the PC running Windows 7 or later and Mac OS 10.10 or later.
- MeetingBar AX0 needs to enable the Wireless AP.

NOTE

To use the content sharing feature on the MeetingBar AX0, you need to enable **Enable HDMI Content Sharing** on MeetingBar A20/A30 with version 133.320.10.1 or later, and on MeetingBar A10 with version 278.320.0.11 or later. Go to **More > General > Content sharing** to view this setting.

How to Use

1. Pair WPP20/WPP30 with MeetingBar AX0

1. Plug the WPP20/WPP30 into the USB-A port of MeetingBar AX0.
2. Unplug the WPP20/WPP30 when the display device prompts “Wireless screen sharer is paired successfully” .

NOTE

After connecting the WPP20/WPP30, the Wireless AP will be automatically enabled, and the wireless network will be disabled. If the Wireless AP is not automatically enabled, go to **More > Settings > Device Settings > Network (default password: 0000)** and enable the Wireless AP.

2. Pair WPP20/WPP30 with PC

Connect WPP20/WPP30 to the PC’ s USB port, and the PC will automatically pop up the Yealink Wireless Presentation Pod window.

NOTE

- When using the Mac system, a prompt will automatically pop up to enable screen recording permission for Yealink Wireless Presentation Pod. If it does not pop up automatically, you can click the upper-left corner of the Mac screen and go to **System Preferences > Security and Privacy > Enable Screen Recording Automatically**. After enabling it, you can start sharing content.
- If the firmware of the WPP20/WPP30 is different from the MeetingBar AX0, the PC will prompt you to update the firmware.
- For the WPP20: If your PC only has a USB-C port, you can connect the standard USB-C adapter to WPP20. The USB-C port of the WPP20 connected to the PC does not support plug-and-share.
- For the WPP30: We recommend using the USB-C port to connect to your PC. (By removing the USB-A adapter on WPP30, you will see the USB-C port.)

3. Start Content Sharing

NOTE

If the WPP30 is connected to the USB-C port of the PC, the content sharing will start automatically. After disabling **Automatically Share to the Room Display (More > General > Content Sharing)**, the content sharing will not immediately start.

Method 1: Share via a button on WPP20/WPP30

Press the presentation button of WPP20/WPP30 to start/stop sharing content.

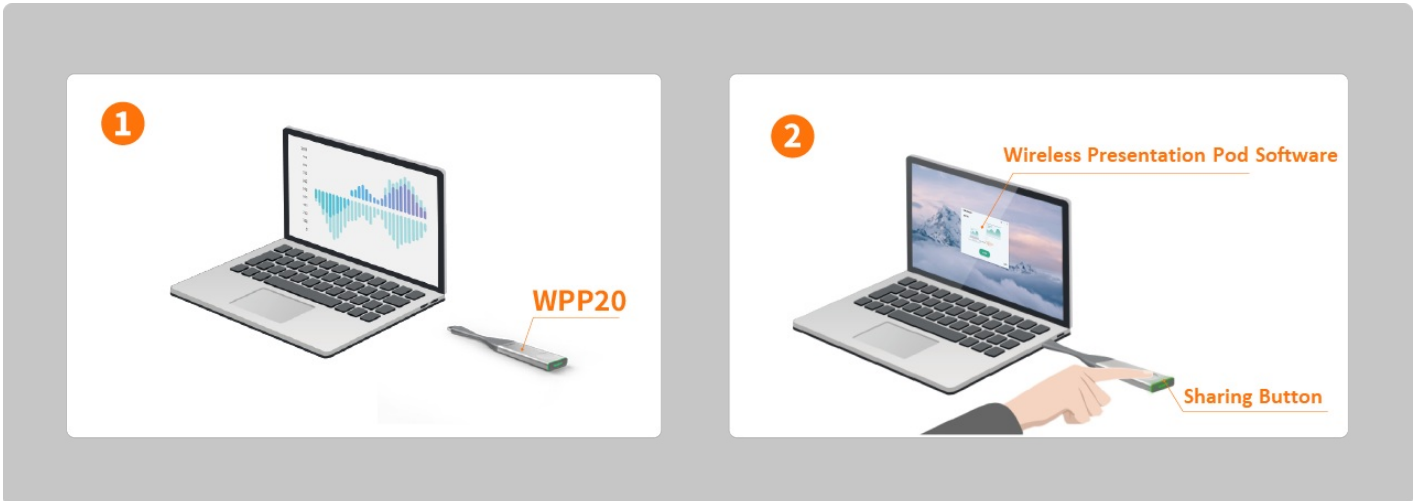
**Method 2: Share via the WPP20/WPP30 software****1. Choose how to share your content:**

- **Duplicate screen:** The screen connected to MeetingBar AX0 and the shared PC screen display the same content. When operating on the PC, the screen connected to MeetingBar AX0 changes synchronously.
- **Extended screen:** The screen connected to MeetingBar AX0 and the shared PC form a complete screen, and you can use the mouse to operate the two screens (WPP20 does not support the extended screen under the Mac system, WPP30 supports it).

NOTE

You need to install an additional driver to use the extended screen. If the Yealink Wireless Presentation Pod detects that the extended screen driver is not installed on the current PC or the driver needs to be updated, the following prompt window will pop up. Click **Install**.

2. Do one of the following to start sharing:

- Click **More** and share your desktop or a running application.
- Click **Press to share** to share your desktop.

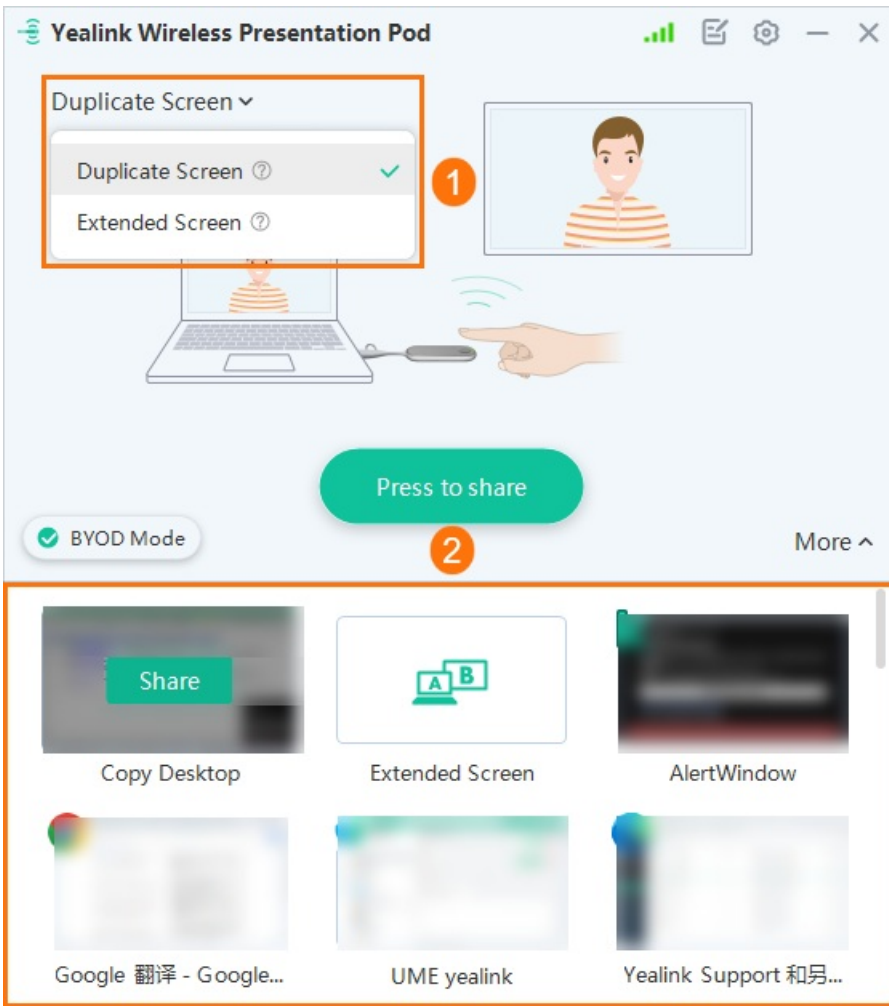

3. During content sharing, you can switch the shared content by accessing the screen sharing options in the status bar at the top of your computer screen.

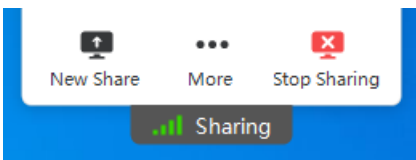

Method 3: Share via the CTP18/AX0

NOTE

If you receive a prompt saying “No device is connected,” please first try enabling the content sharing feature using Method 1 or Method 2.

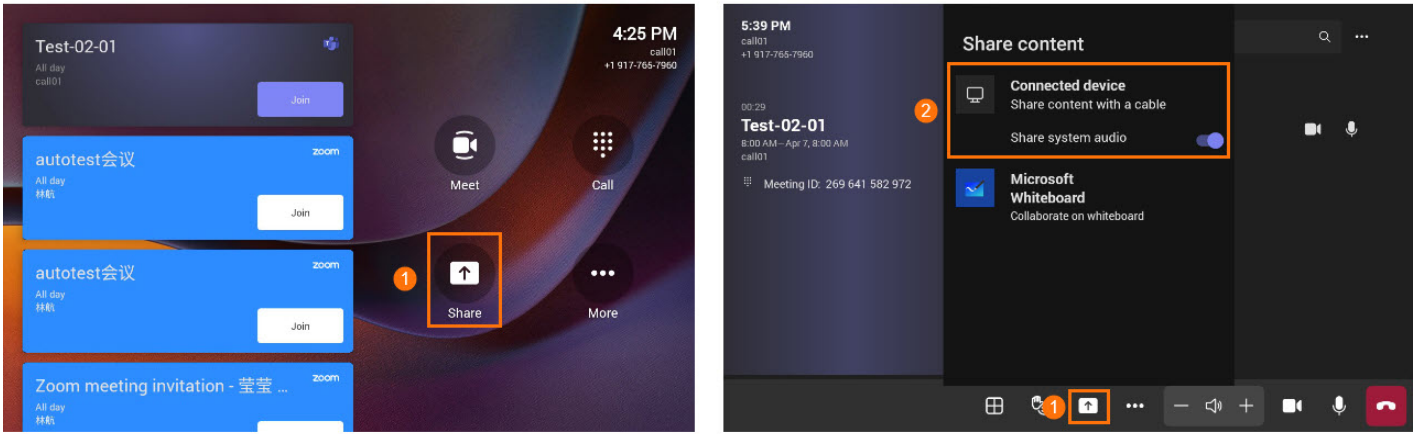

4. Share Audio

The WPP20/WPP30 transmits all system audio output from your device. For example, if you have application audio notifications enabled during content sharing, participants hear these notification sounds together with the content audio.

To avoid audio interference, the system automatically mutes your local audio when you start sharing content. When you stop sharing content, the system restores your local audio to its initial status.

NOTE

MeetingBar A20/A30 with firmware version 133.320.10.1 or later, and MeetingBar A10 with firmware version 278.320.0.11 or later, support audio sharing during content sharing and ensure that **Include Audio (More > General > Content Sharing)** is enabled by default.

When using WPP30 for content sharing, audio sharing is enabled by default. If the audio is not successfully played on the MeetingBar AX0, please check if your computer is set to use the MeetingBar AX0 speaker (Yealink Audio). When using WPP20 for content sharing, click **More > Share Computer Sound** to enable audio sharing in the Yealink Wireless Presentation software.

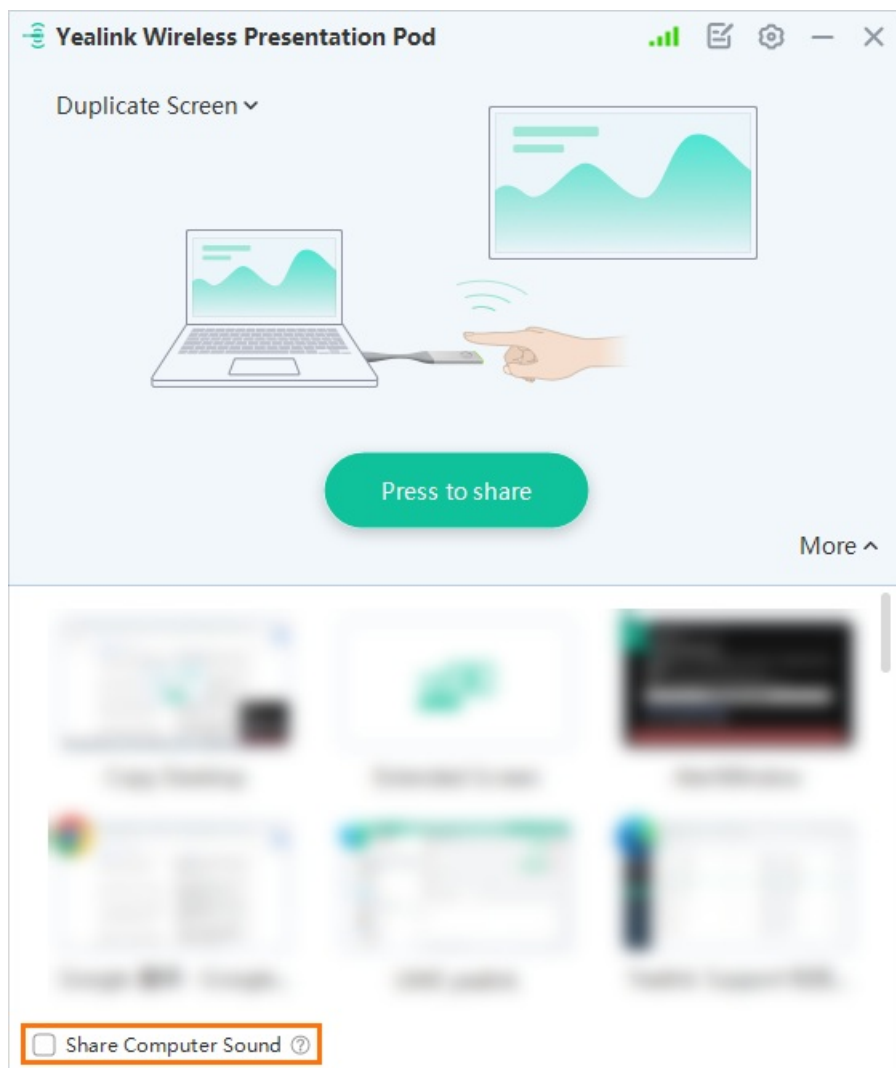

5. Stop Content Sharing

Do one of the following:

- Press the **presentation** button of WPP20/WPP30 again.
- Click **Stop Sharing** in the status bar at the top of your computer screen.
- Click **Share** button again on CTP18/MeetingBar AX0.

FAQ

[A10/A20/A30 failed to share audio with WPP20/WPP30/VCH51/USB-C cable?](#)

[Failed to connect to or pair with WPP20/WPP30? Failed to share content with an error code 0020001?](#)

[Why is the shared content out of sync when using WPP20/WPP30 to share content?](#)

When you connect WPP20/WPP30 to a PC, the PC does not pop up Yealink Wireless Presentation Pod. The Yealink

Wireless Presentation Pod does not pop up automatically.

If the WPP20/WPP30 is connected to the PC for the first time, the Yealink Wireless Presentation Pod software does not pop up automatically, and please follow the steps below:

1. Click **This PC > Devices and drives**.
2. Double-click **CD drive** to start the **Yealink Wireless Presentation Pod**.

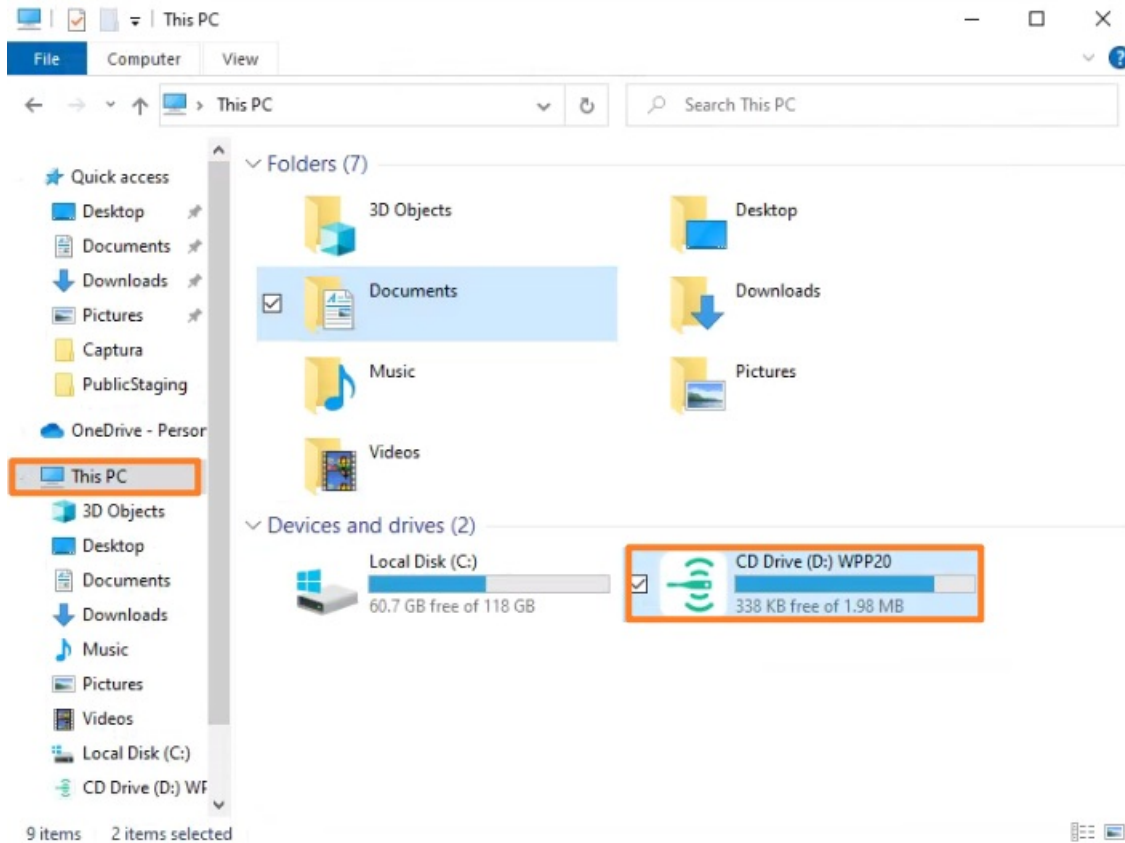

How to update the Yealink Wireless Presentation Pod?

1. Insert the WPP20/WPP30 into the MeetingBar for pairing, then plug it into the PC. It will prompt you to update the firmware if it is inconsistent with the compatible version of the MeetingBar software.
2. If the automatic update is abnormal, you can enter the web user interface of the MeetingBar after the pairing is successful. Go to **System > Update** to manually upload the firmware of WPP20/WPP30 to update.
3. For the manual update, please refer to [How to upgrade WPP20/WPP30 manually](#).

Wired Content Sharing

Introduction

The MeetingBar A20/A30 can share content sharing when connected to a PC via the VCH51.

The MeetingBar A10 can also be connected to a PC via a USB-C cable for content sharing.

MeetingBar A10/A20/A30 (Hereinafter referred to as MeetingBar AX0) with VCH51/USB-C cable supports the content

sharing feature in an idle state or a Teams meeting. You can share your desktop, and the resolution supports up to 1080p 30fps when sharing content.

In an idle state or a Teams meeting, only one content sharing is supported (including local and remote participants' content sharing).

If multiple screens are being shared simultaneously, the content of the previous screen sharing will be replaced by the content of the later one (regardless of whether it is wired or wireless screen sharing).

For the operation video, please refer to [Content Sharing](#).

VCH51 Compatibility

For VCH51 compatibility, please refer to [Teams Room Accessories Compatibility Lists](#).

Before You Begin

- You need to log in to your Microsoft Teams account in MeetingBar AX0.
- Before using CTP18 to operate MeetingBar AX0, the two devices need to be paired.
- Please make sure your PC has a Type-C port or HDMI port.
- We recommend using the cable provided in the packaging, please refer to [MeetingBar A10](#), [MeetingBar A20](#), and [MeetingBar A30](#). (Using USB cables meant for charging devices may not be able to transmit data.)

NOTE

To use the content sharing feature on the MeetingBar AX0, you need to enable **Enable HDMI Content Sharing** on MeetingBar A20/A30 with version 133.320.10.1 or later, and on MeetingBar A10 with version 278.320.0.11 or later. Go to **More > General > Content sharing** to view this setting.

How to Use

1. Share Content via VCH51 (For A20/A30)

- **Connect VCH51 to MeetingBar A20/A30**

Method 1: Connect the VCH51 to the MeetingBar A20/A30 directly.

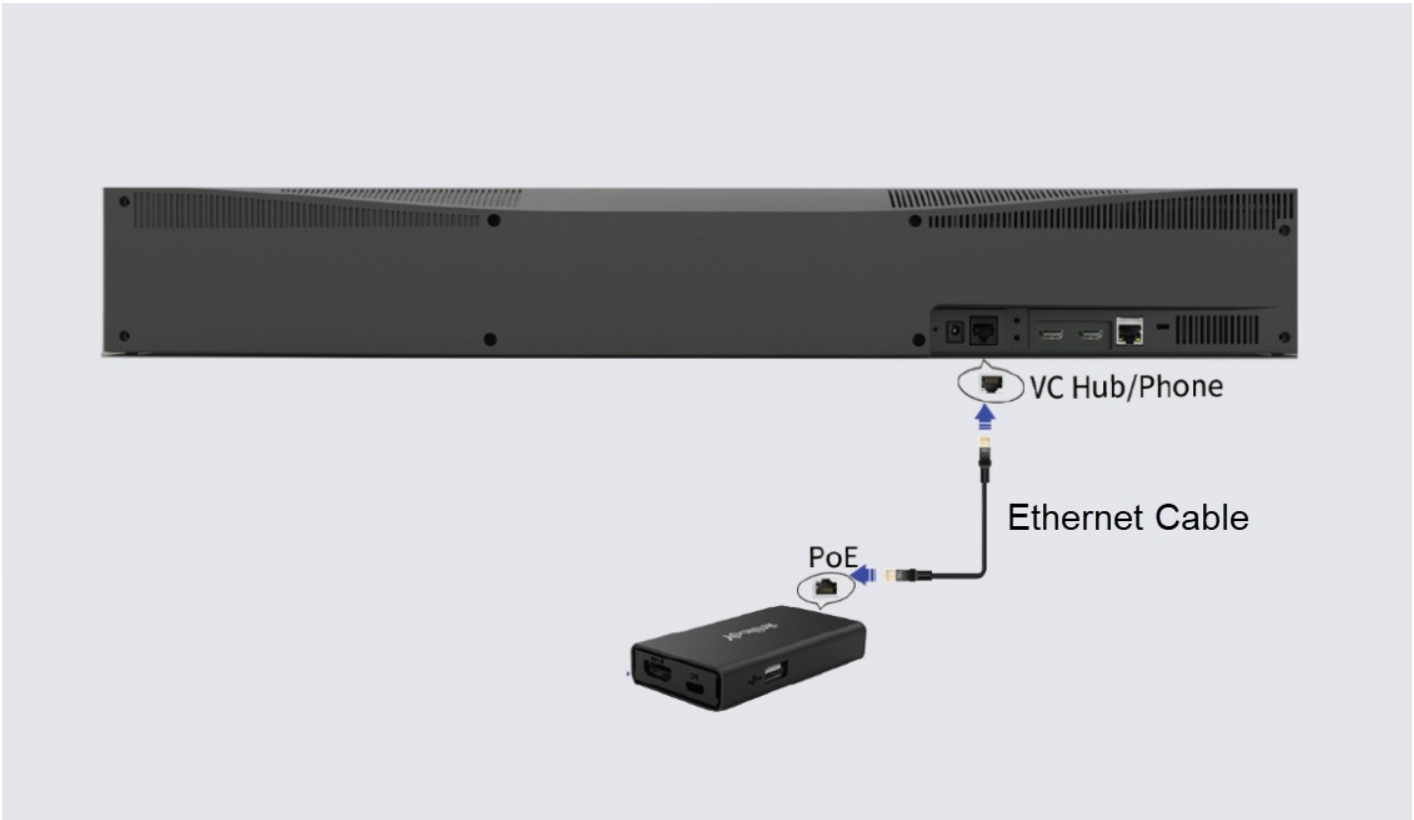

Method 2: Connect the VCH51 to the MeetingBar A20/A30 via a PoE switch.

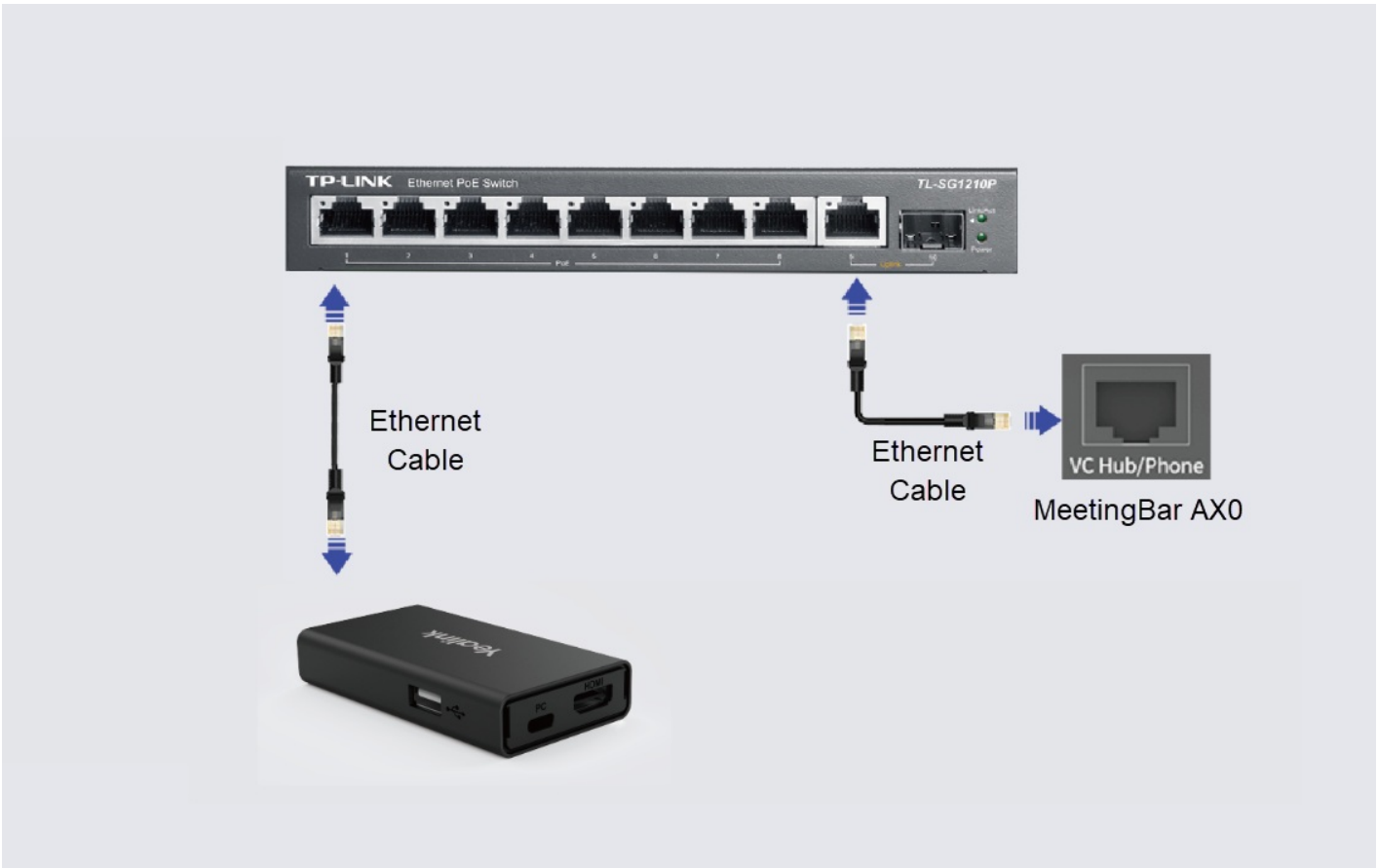

- Connect VCH51 to PC

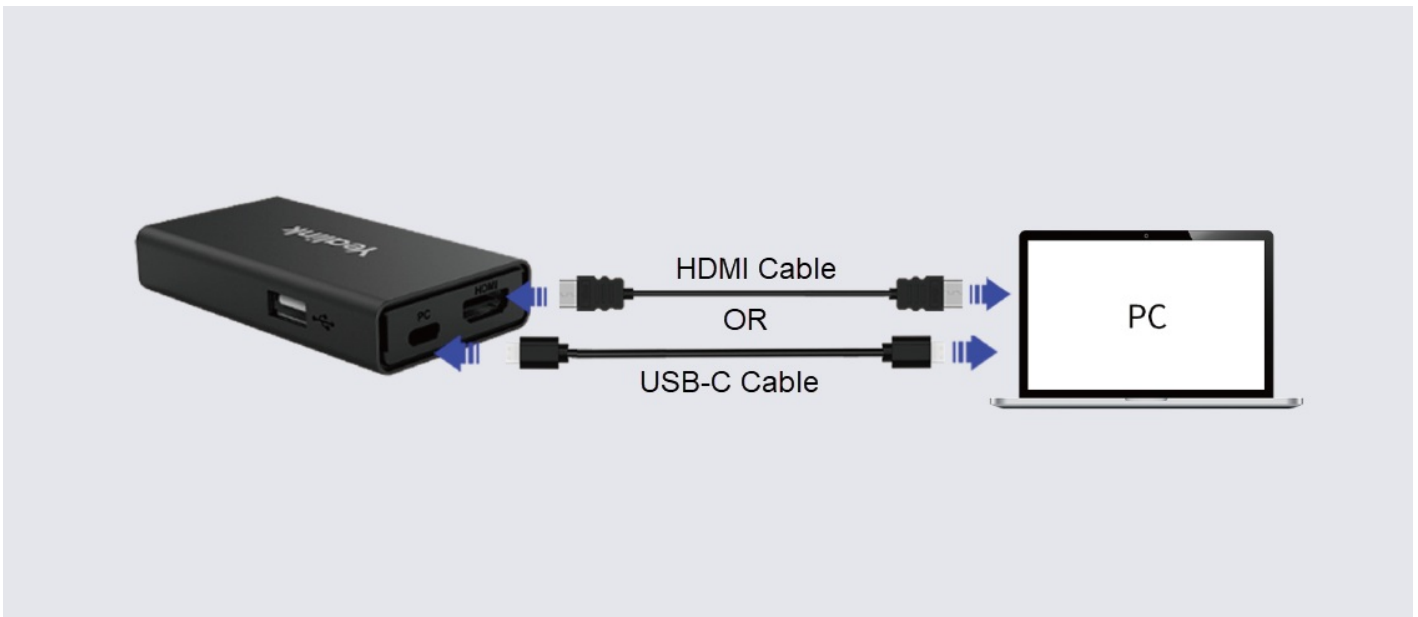

2. Share Content via USB-C (For A10)

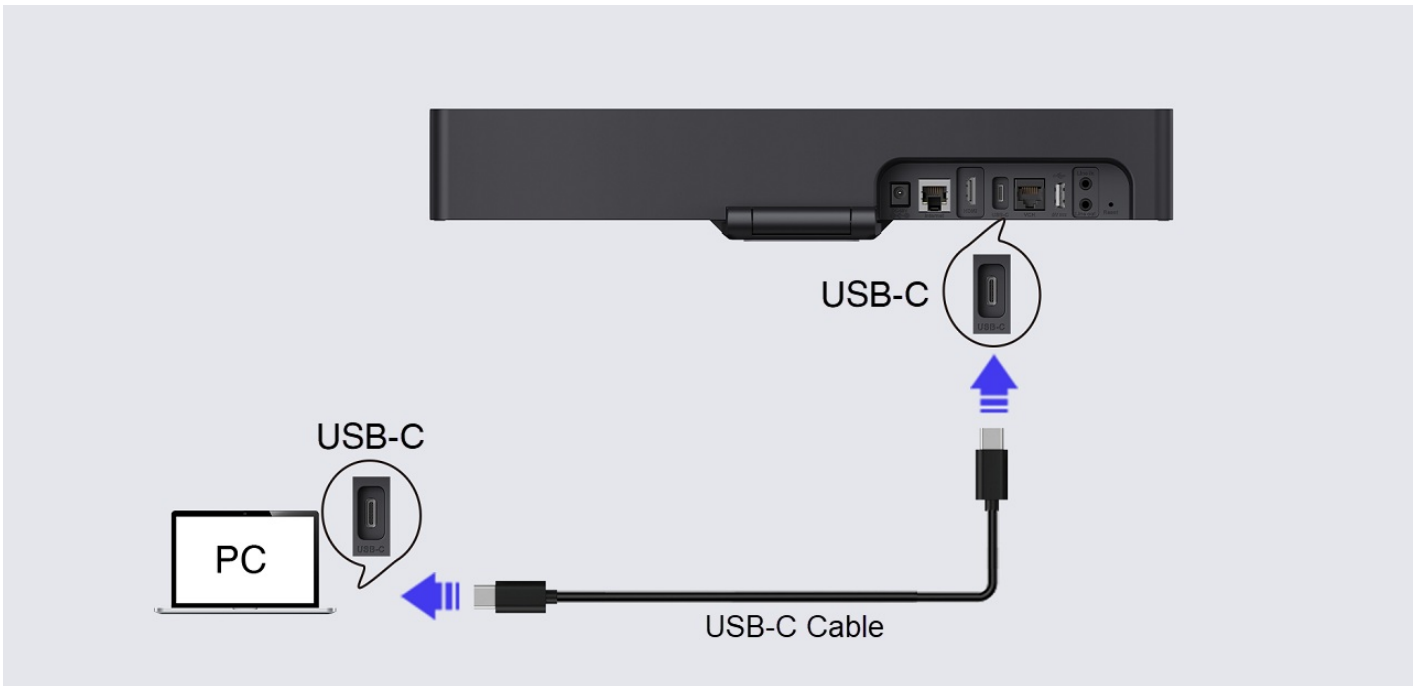

3. Start Content Sharing

NOTE
 Disable **Automatically Share to the Room Display** (**More > General > Content Sharing**) does not immediately start content sharing after connecting the MeetingBar AX0.

MeetingBar AX0 automatically shares content after connecting, or you can share the content by tapping **Share** button.

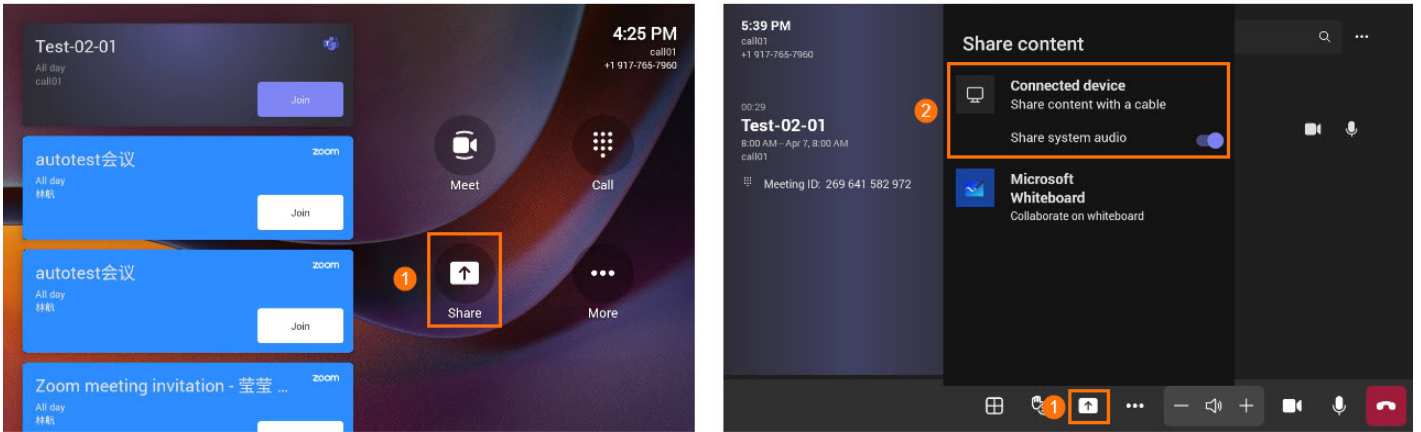

4. Share Audio

The VCH51/USB-C cable transmits all system audio output from your device. For example, if you have application audio notifications enabled during content sharing, participants hear these notification sounds together with the content audio.

To avoid audio interference, the system automatically mutes your local audio when you start sharing content. When you stop sharing content, the system restores your local audio to its initial status.

NOTE

MeetingBar A20/A30 with firmware version 133.320.10.1 or later, and MeetingBar A10 with firmware version 278.320.0.11 or later, support audio sharing during content sharing and ensure that **Include Audio (More > General > Content Sharing)** is enabled by default.

5. Stop Content Sharing

Do one of the following:

- Disconnect the HDMI cable or USB-C cable from the PC.
- Press the **OK** button on the remote control, and **Stop Sharing** and **Exit Full Screen** will appear in the lower-right corner of the MeetingBar AX0 display. Click **Stop Sharing** to stop content sharing.
- Tap **Stop Sharing** on the CTP18/MeetingBar AX0.

FAQ

Why is the shared content out of sync when using WPP20/WPP30 to share content?

A10/A20/A30 failed to share audio with WPP20/WPP30/VCH51/USB-C cable?

USB Device Mode

Wired Device Mode

Introduction

BYOD, i.e., Bring Your Own Device. After entering BYOD mode, you can take MeetingBar A10/A20/A30 as the peripherals for meetings held by third-party apps. When there is a meeting on the PC, you can use the camera, speaker, and microphone of MeetingBar A20/A30 and display the PC content on the screen connected to MeetingBar A20/A30.

Wired USB Device Mode: Connect MeetingBar A20/A30 to PC via VCH51.

Wired USB Device Mode: Connect MeetingBar A10 to PC via Type-C cable.

For the operation video, please refer to [Wired Device Mode](#).

*Coming soon.

Before You Begin

- Before using CTP18 to operate MeetingBar AX0, the two devices need to be paired.
- Please make sure your PC has a Type-C port or HDMI/USB-A Port.
- We recommend using the cables provided in the package. Please refer to the user manuals for [MeetingBar A10](#), [MeetingBar A20](#), and [MeetingBar A30](#). (For Device Mode, we recommend using USB 2.0 or later cables. USB cables designed for charging devices may not be able to transmit data.)

How to Use

1. Enable USB Device Mode

Standalone USB Mode

Do one of the following:

- When you select a platform on MeetingBar AX0, you can choose Device Mode. For more information, please refer to [Quick Setup](#).
- Reset the MeetingBar AX0 to factory settings and select **Device Mode**.

Device Mode in Teams Mode

In [the web user interface](#) of MeetingBar AX0, go to **System** > **UC Provider** to enable **BYOD Mode Enable** and click **Confirm**.

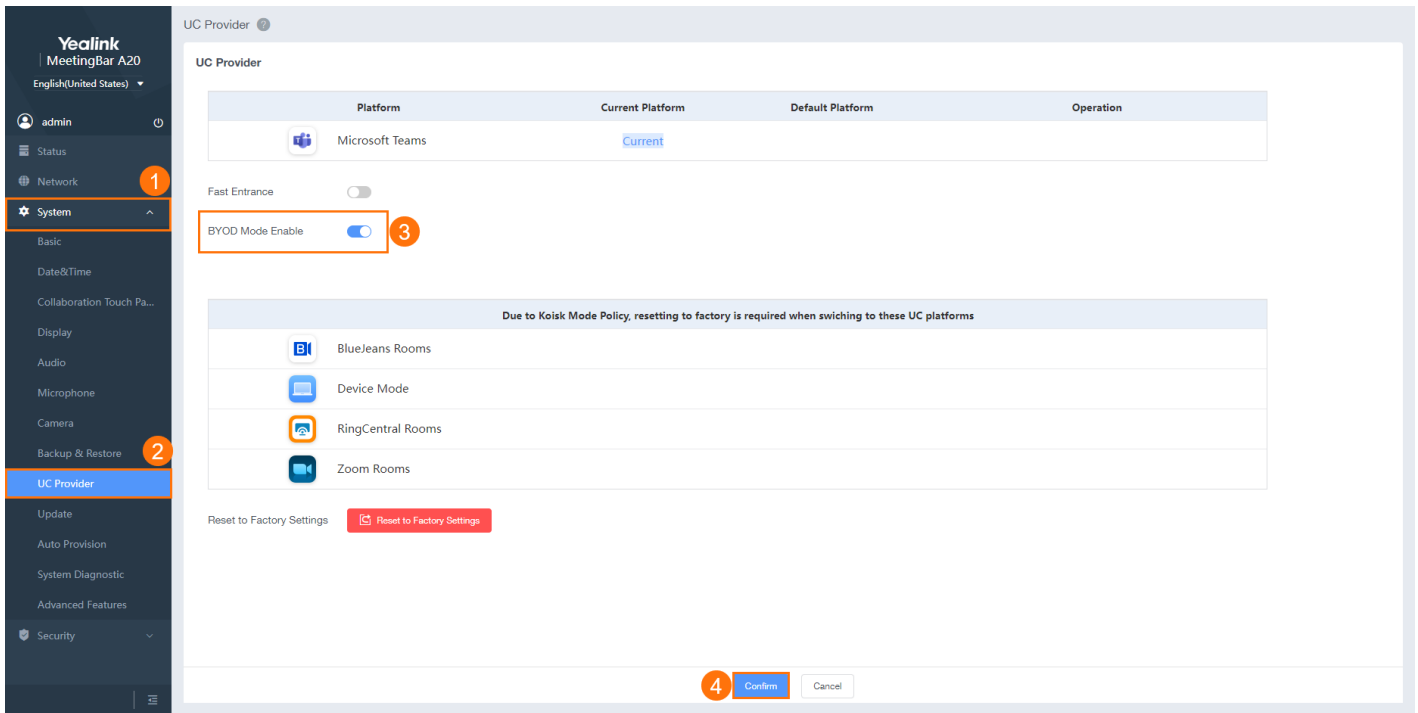

2. Device Mode Connection

- Connect via VCH51 (for MeetingBar A20/A30)

Method 1: If your computer has a USB-C port.

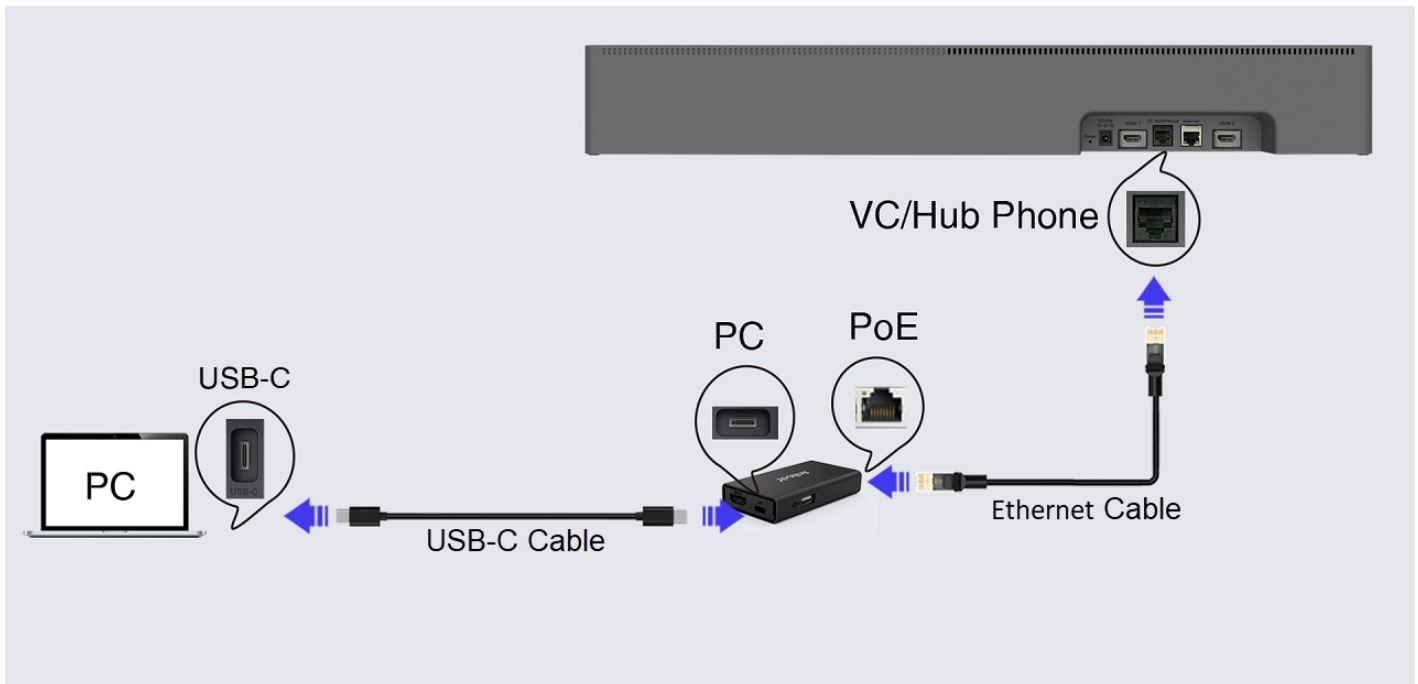

Method 2: If your computer does not have a USB-C port.

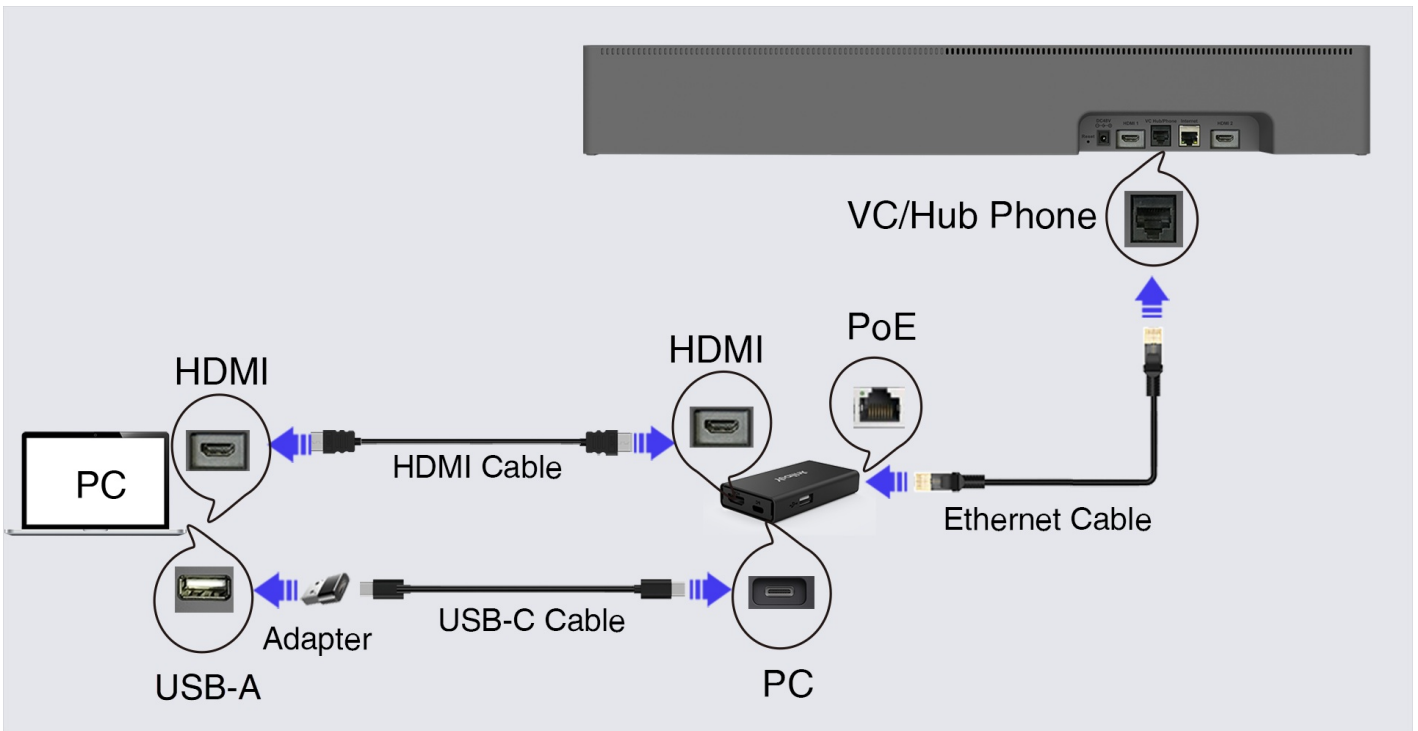

- **Connect via Type-C cable (for A10)***

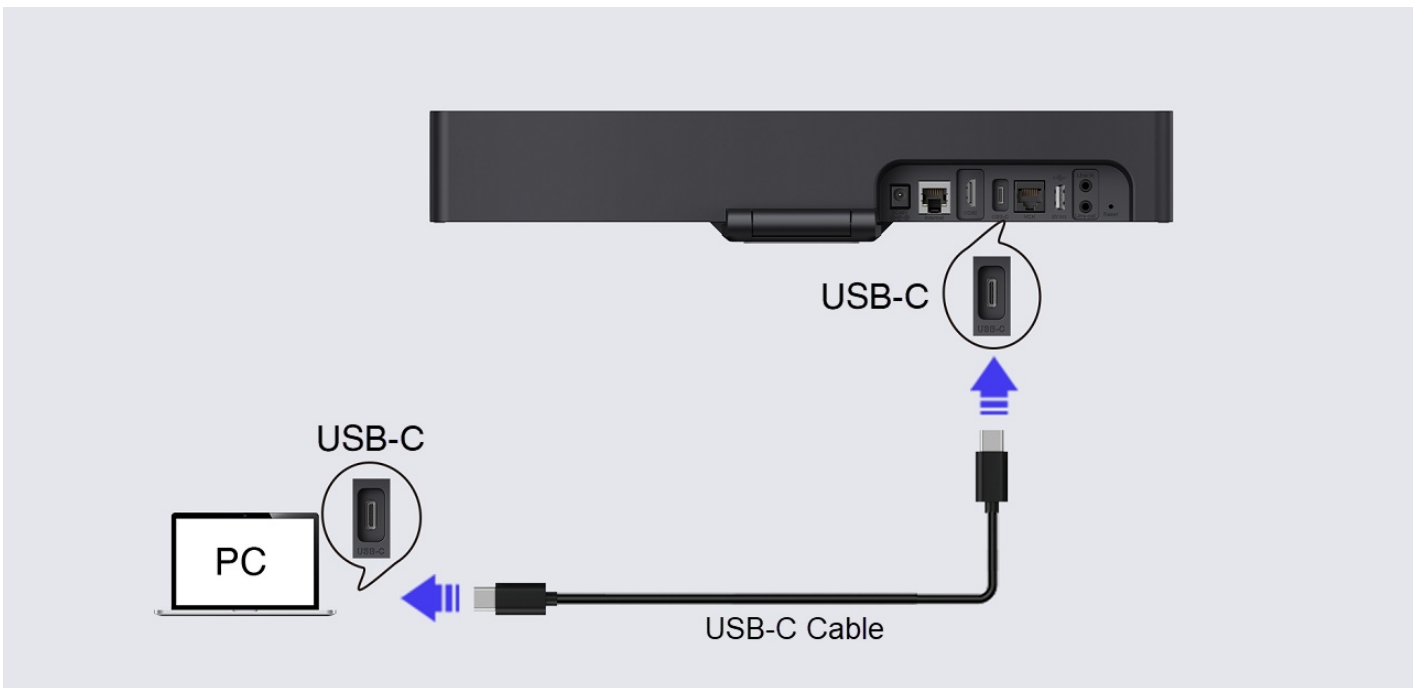

3. Enter Device Mode

Standalone Device Mode

You can use it immediately after connecting.

Device Mode in Teams Mode

After connecting, a prompt will appear at the top of the device screen asking whether to enter Device Mode. Use the remote control or the CTP18 to enter Device Mode.

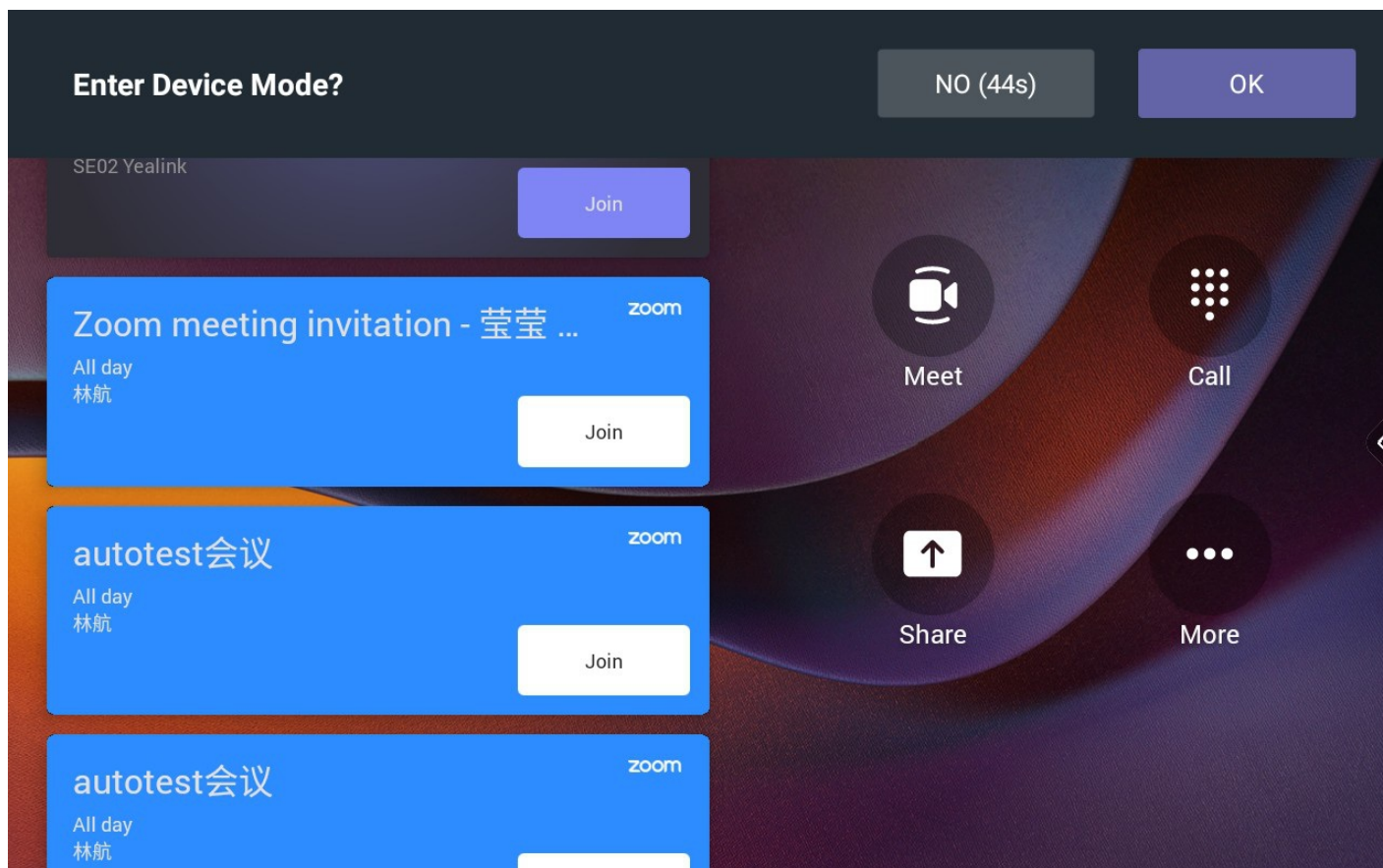

4. Usage

① NOTE

- The MeetingBar AX0 supports microphone connectivity. For more information, please refer to [Teams Room Accessories Compatibility Lists](#).
- In Device Mode under Teams Mode, your video system will reject incoming calls.

1. Make sure that the microphone and speaker device of the PC has selected the Yealink Room SpeakerPhone (i.e., MeetingBar AX0).

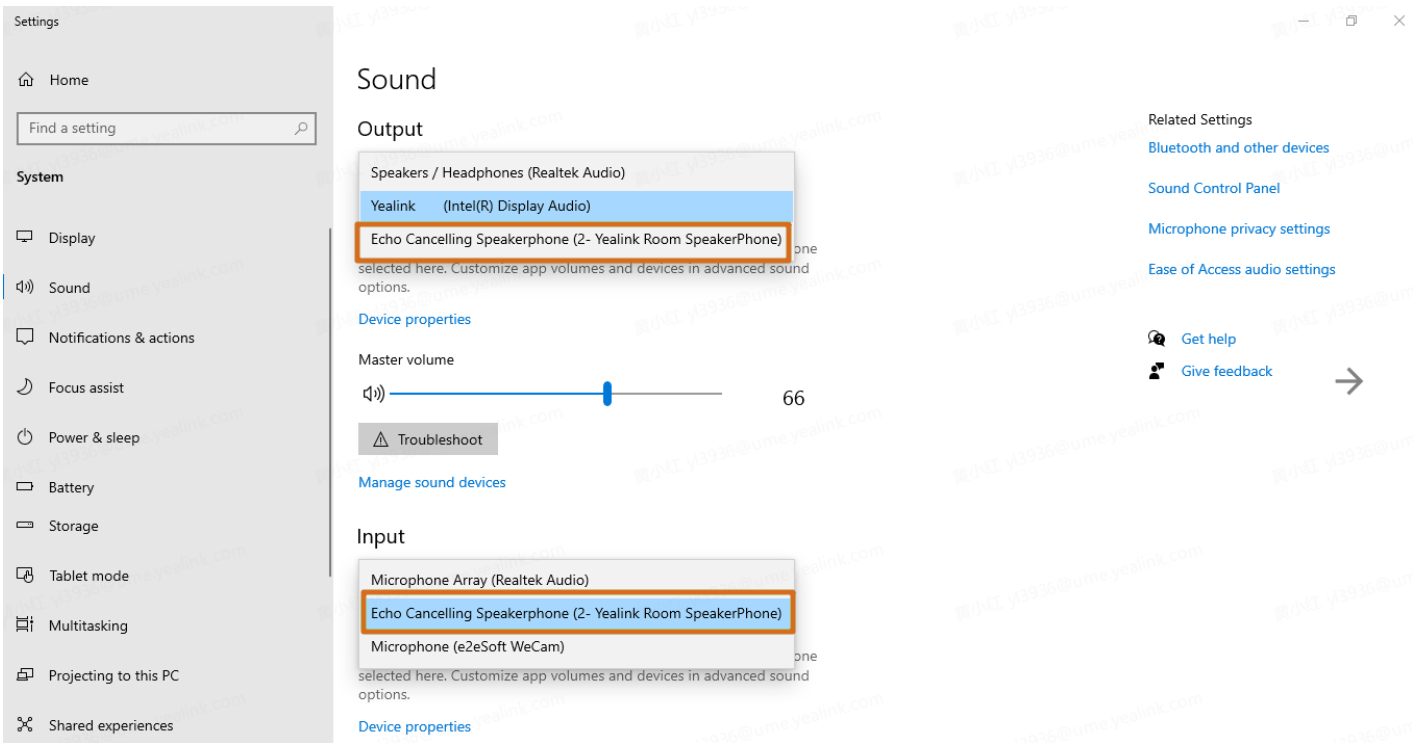

2. You can adjust the volume and control the camera using the CTP18 or remote control. When using the remote control, press the **OK** button to open the menu, and use the volume keys to adjust the speaker volume.

NOTE
 If you receive a camera initialization failure message, please check if the meeting is set to use the MeetingBar AX0 camera (Yealink Room Camera).

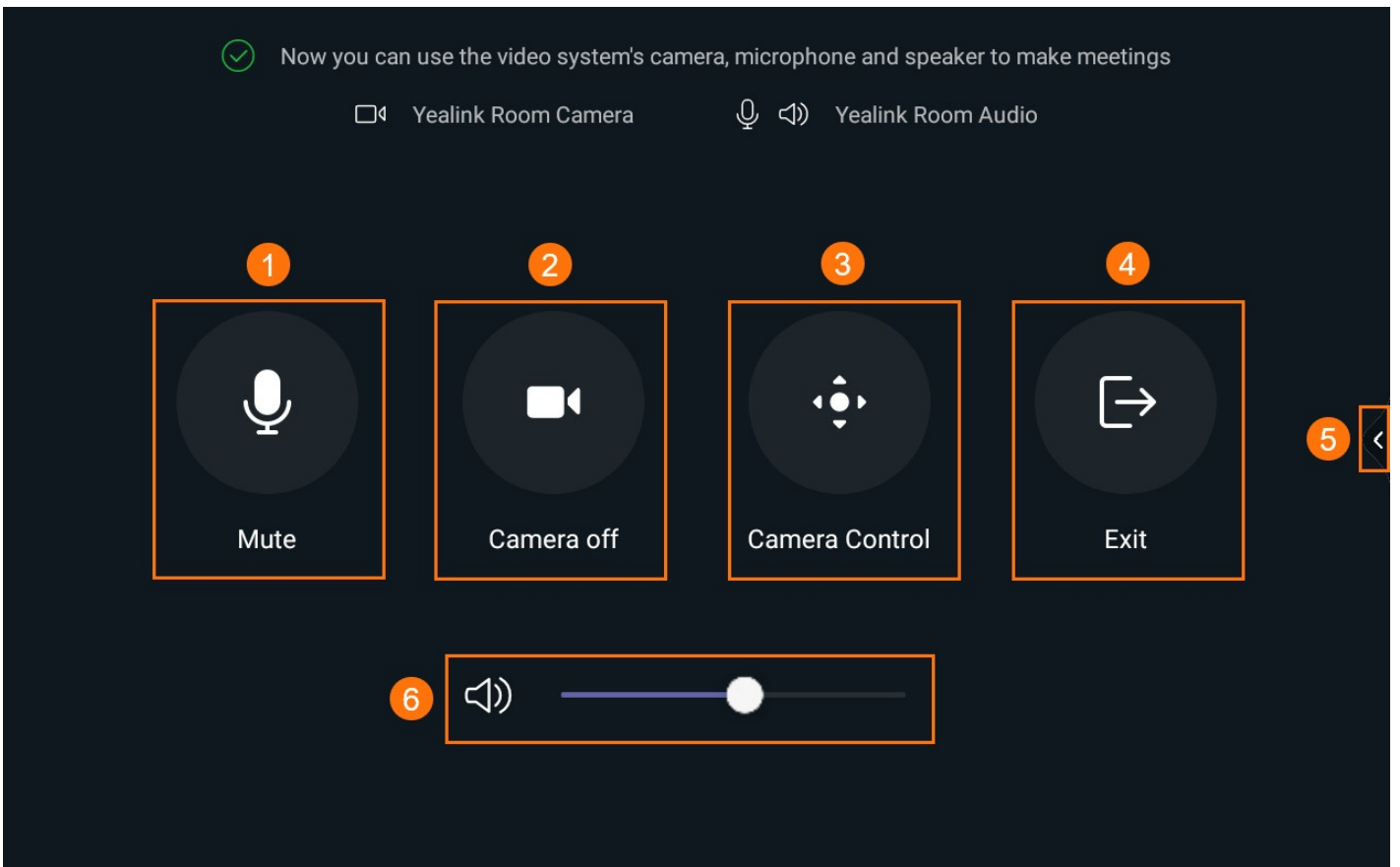

No.	Description
1	Enable/disable the MeetingBar AX0 microphone.
2	In a meeting, enable/disable the MeetingBar AX0 camera.
3	After enabling the camera, you can control it. For more information, please refer to Camera Control .
4	To exit Device Mode and switch back to the original platform' s homepage <div style="background-color: #f0e6ff; padding: 10px; border: 1px solid #ccc;"> <p>ⓘ Note In standalone Device Mode, there is no Exit button available, and switching back to the original platform requires to reset to factory.</p> </div>
5	Control the device to return to the home page, configure settings and camera, and enter the Help Center.
6	Adjust the volume of the MeetingBar AX0 speaker.

3. If you connect the WPP30 to a USB-C port on your PC, the PC will immediately share content. If you connect the WPP30 to a USB-A port, you can choose either of the following methods to start the content sharing:

- Press the **Presentation** button on the WPP30.
- Click **Share** in the Yealink Wireless Presentation Pod software that pops up on your PC.

5. Exit Device Mode

Standalone Device Mode

To exit standalone Device Mode and choose another platform, you need to [reset to factory](#) and switch platforms.

Device Mode in Teams Mode

Do one of the following:

- Disconnect the connected HDMI cable and USB-C cable.
- On the CTP18, tap **Exit**.
- Press the **OK** button on the remote control to open the menu and select **Exit**.

FAQ

[Failed to enter Device Mode \(BYOD\) on MeetingBar A10/A20/A30?/No BYOD button on WPP software?](#)

Does the Wired Device Mode also support Auto Framing and Speaker Tracking features?

If your MeetingBar AX0 enables Auto Framing and Speaker Tracking features, these features are still supported when you switch to Device Mode.

Wireless Device Mode

Introduction

BYOD, i.e., Bring Your Own Device. After entering BYOD mode, you can take MeetingBar A10/A20/A30 as the peripherals for meetings held by third-party apps. When there is a meeting with the PC, you can use the camera, speaker, and microphone of MeetingBar AX0 (hereinafter referred to as MeetingBar AX0) and display the PC content on the screen connected to MeetingBar AX0.

MeetingBar AX0 must be connected to WPP30 to support the wireless Device Mode.

For the operation video, please refer to [Wireless Device Mode](#).

Before You Begin

- Before using CTP18 to operate MeetingBar AX0, the two devices need to be paired.
- MeetingBar AX0 needs to enable the Wireless AP.

How to Use

1. Enable Device Mode

Standalone Device Mode

Do one of the following:

- When you select a platform on MeetingBar AX0, you can choose **Device Mode**. For more information, please refer to [Quick Setup](#).
- Reset the MeetingBar AX0 to factory settings and select **Device Mode**.

Device Mode in Teams Mode

In the web user interface of MeetingBar AX0, go to **System > UC Provider** to enable **BYOD Mode Enable** and click **Confirm**.

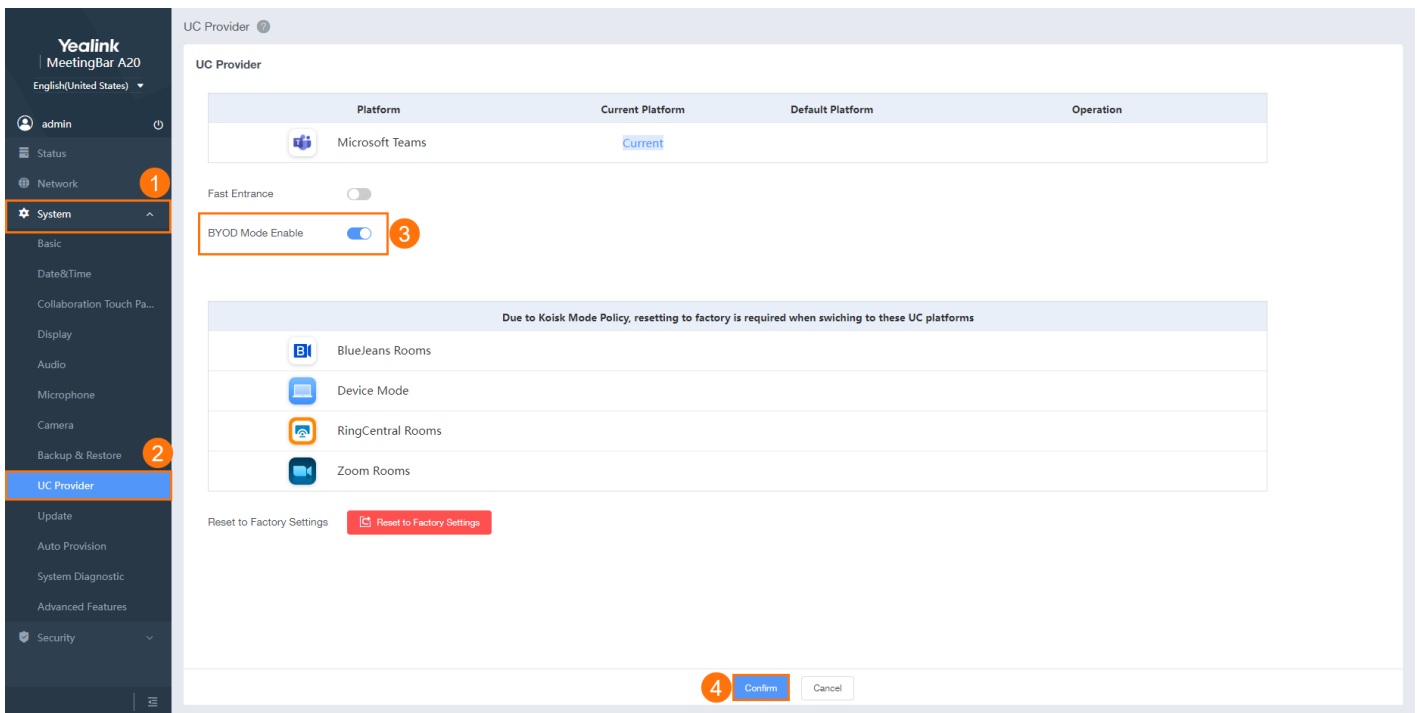

2. Enter Device Mode

NOTE

- If the firmware of the WPP30 is different from the MeetingBar AX0, the PC will prompt you to update the firmware.
- After connecting the WPP30, the Wireless AP will be automatically enabled, and the wireless network will be turned off. If the Wireless AP is not automatically enabled, go to **More > Settings > Device Settings > Network (default password: 0000)** and enable the **Wireless AP**.

1. Plug the WPP30 into the USB-A port of MeetingBar AX0.
2. Unplug the WPP30 when the display device prompts “Wireless screen sharer is paired successfully” .
3. Connect the WPP30 to the Type-A port of the PC port.

3. Usage

NOTE

- The MeetingBar AX0 supports microphone connectivity. For more information, please refer to [Teams Room Accessories Compatibility Lists](#).
- In Device Mode under Teams Mode, your video system will reject incoming calls.

1. Make sure that the microphone and speaker device of the PC has selected the Yealink Room SpeakerPhone (i.e., MeetingBar AX0).

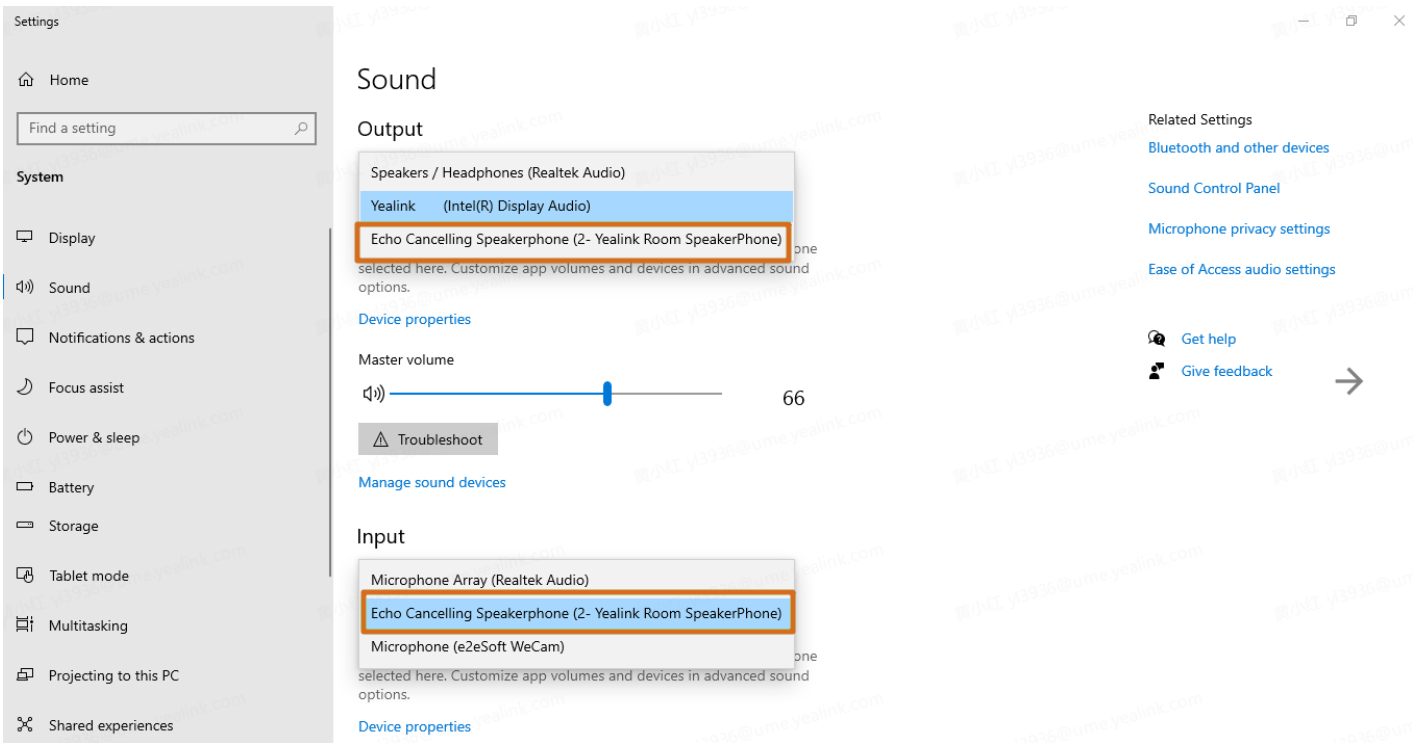

2. You can adjust the volume and control the camera using the CTP18 or remote control. When using the remote control, press the **OK** button to open the menu, and use the volume keys to adjust the speaker volume.

NOTE
 If you receive a camera initialization failure message, please check if the meeting is set to use the MeetingBar AX0 camera (Yealink Room Camera).

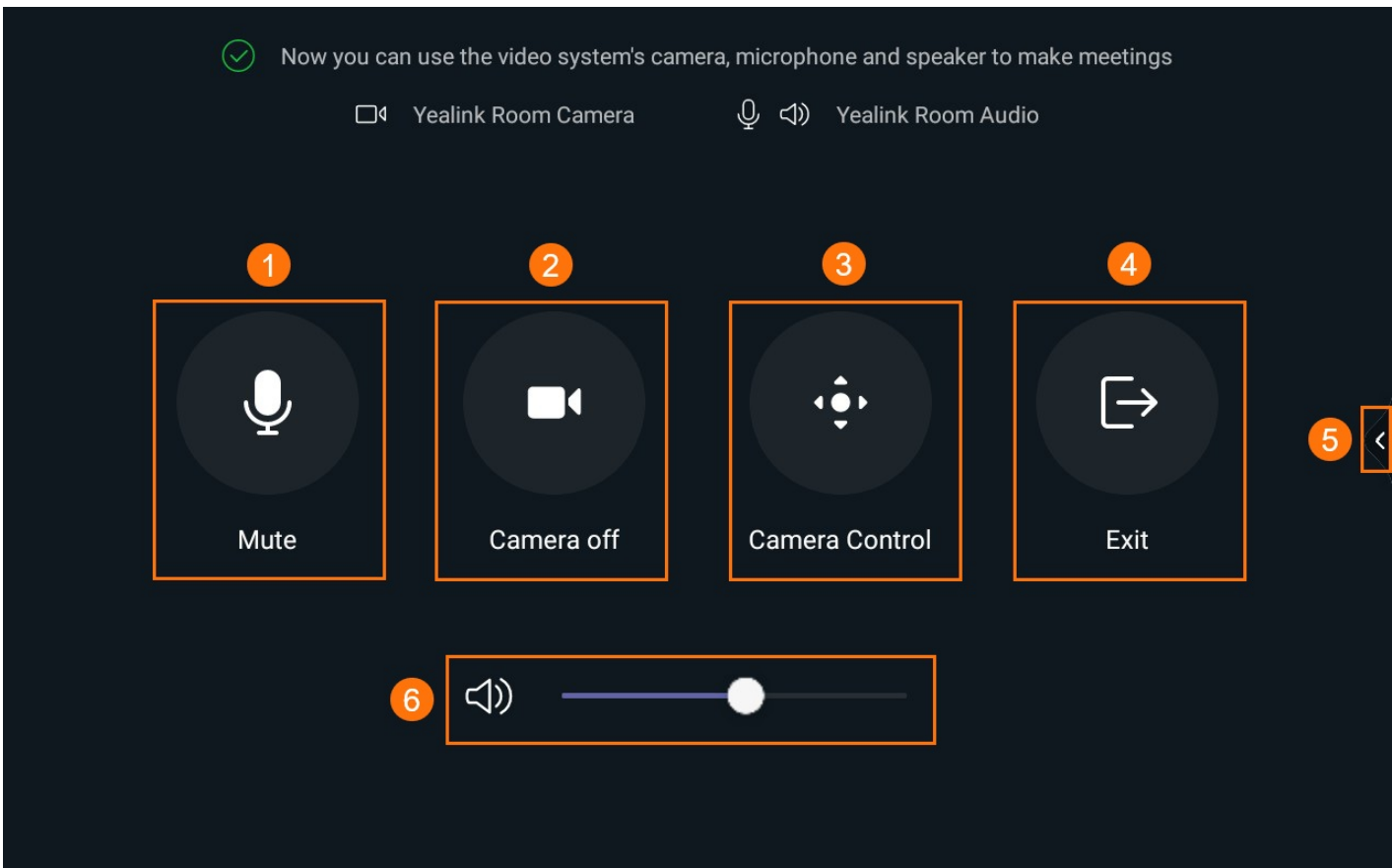

No.	Description
1	Enable/disable the MeetingBar AX0 microphone.
2	In a meeting, enable/disable the MeetingBar AX0 camera.
3	After enabling the camera, you can control it. For more information, please refer to Camera Control .
4	To exit Device Mode and switch back to the original platform' s homepage <div style="background-color: #e6e6fa; padding: 10px; border: 1px solid #d1c4e9;"> <p>ⓘ Note In standalone Device Mode, there is no Exit button available, and switching back to the original platform requires to reset to factory.</p> </div>
5	Control the device to return to the home page, configure settings and camera, and enter the Help Center.
6	Adjust the volume of the MeetingBar AX0 speaker.

3. If you connect the WPP30 to a USB-C port on your PC, the PC will immediately share content. If you connect the WPP30 to a USB-A port, you can choose either of the following methods to start the content sharing:

- Press the **Presentation** button on the WPP30.
- Click **Share** in the Yealink Wireless Presentation Pod software that pops up on your PC.

4. Exit Device Mode

Standalone Device Mode

To exit standalone Device Mode and choose another platform, you need to [reset to factory](#) and switch platforms.

Device Mode in Teams Mode

Do one of the following:

- Unplug the WPP30.
- On the CTP18, tap **Exit**.
- Press the **OK** button on the remote control to open the menu and select **Exit**.
- Click on the **BYOD Mode** option again in the Yealink Wireless Presentation Software and uncheck it.

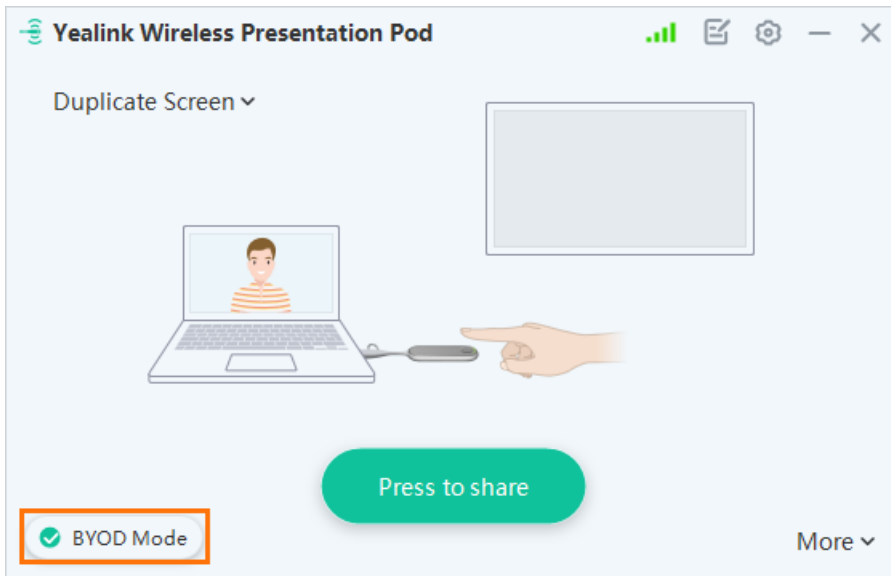

FAQ

The Yealink Wireless Presentation Pod does not pop up automatically.

1. Click **This PC > Devices and drives**.
2. Double-click **CD drive** to start the **Yealink Wireless Presentation Pod**.



Camera Controls

Camera Preset

Introduction

You can set the camera preset in advance using the manual control mode. Presets specify the settings of the camera's angle and focal length that can be used to point a camera at a pre-defined location quickly.

For the operation video, please refer to [Camera Preset](#).

NOTE

- MeetingBar A10/A20/A30 (hereinafter referred to as MeetingBar AX0) supports up to 9 preset positions.
- After enabling the Intelligent Tracking, you cannot manually adjust the camera. The camera can only be adjusted after disabling.



How to Use

NOTE

- You can use CTP18/VCR11/VCR20 to control MeetingBar A20/A30, and use CTP18/VCR11 to control MeetingBar A10.
- The VCR11 remote control supports applying or replacing presets by pressing the number keys 1-9, but the VCR20 does not.
- The default remote control is VCR11. If using VCR20 to operate, please make sure to configure the remote control as VCR20 on the web user interface. For more information, please refer to [Configure Remote Control](#).

1. Add Camera Preset

• With the Remote control

1. Before a meeting, press and hold the Home  button on VCR11 or the Teams  button on VCR20 for 5 seconds to bring up the sidebar.
2. Go to **Settings > Camera > Camera Settings** to [adjust the camera angle](#).
3. Press the **OK** button on the remote control to open the menu and select **Preset**. Select **Add** to add a preset (up to 9 presets can be added).

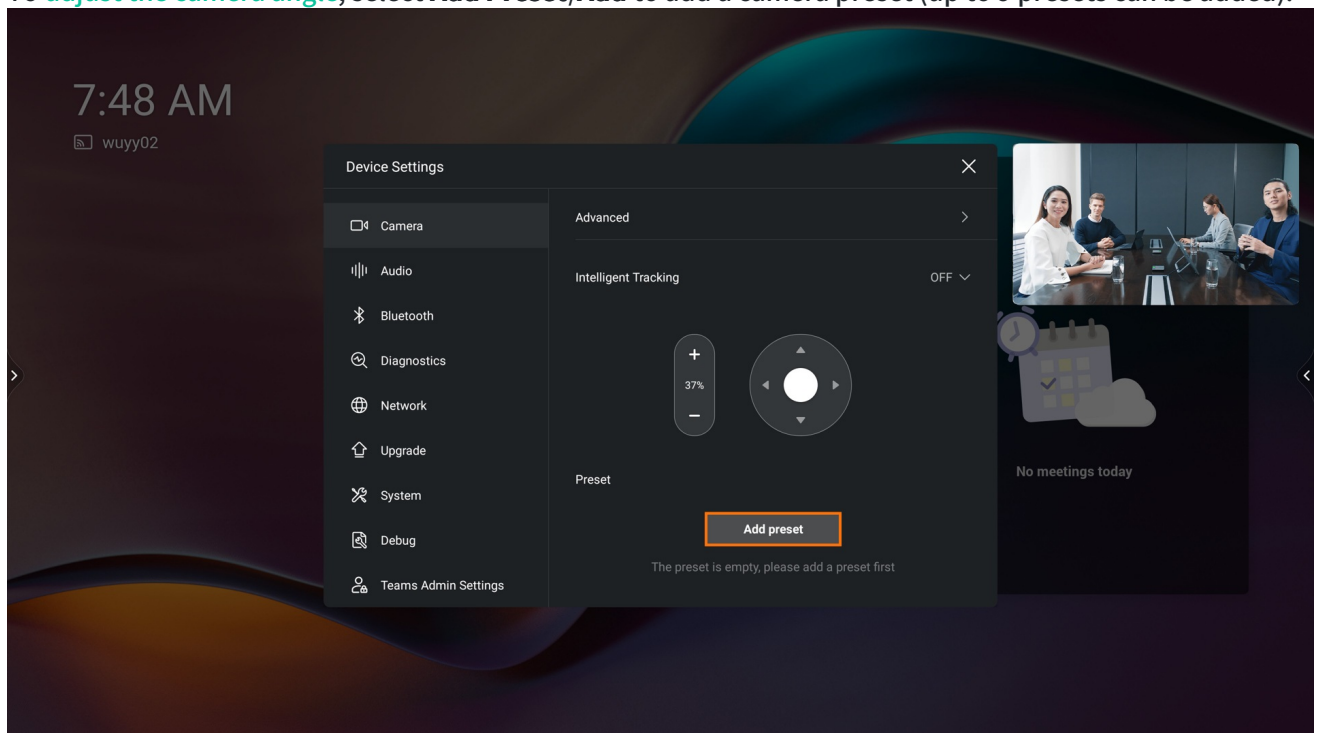

• With the CTP18

1. Before a meeting, go to  **Camera Control**.
2. Tap **Camera Preview** to enable the camera to preview the camera effect.
3. To [adjust the camera angle](#), select **Add Preset/Add** to add a camera preset (up to 9 presets can be added).



2. Apply Camera Preset

- **With the Remote control**



1. During or before a meeting, press and hold the Home  image.png button on VCR11 or the Teams  button on VCR20 for 5 seconds to bring up the sidebar.
2. Press the number keys 1-9 on the VCR11 remote control to apply the corresponding preset position. Or press the **OK** button on the remote control to open the menu and select **Preset**, and select a camera preset on the left side to apply it.

- **With the CTP18**



1. During or before a meeting, go to  **Camera Control**.
2. Tap **Screen preview** to enable the camera to preview the camera effect.
3. Select the preset position to apply it.

3. Replace Camera Preset

- **With the Remote control**

1. Before a meeting, press and hold the Home  image.png button on VCR11 or the Teams  button on VCR20 for 5 seconds to bring up the sidebar.
2. Go to **Settings > Camera > Camera Settings** to [adjust the camera angle](#).
3. Press the **OK** button on the remote control to open the menu and select **Preset**. Select **Replace** to replace the preset with a new one. If you use a VCR11 remote control, press and hold the number keys 1-9 for 5 seconds to replace the corresponding camera preset.

- **With the CTP18**

1. Before a meeting, go to  > **More**.
2. Tap **Camera Preview** to enable the camera to preview the camera effect.
3. To **adjust the camera angle**, select  > **Replace** on the upper-right of the corresponding camera preset to replace the preset with a new one.

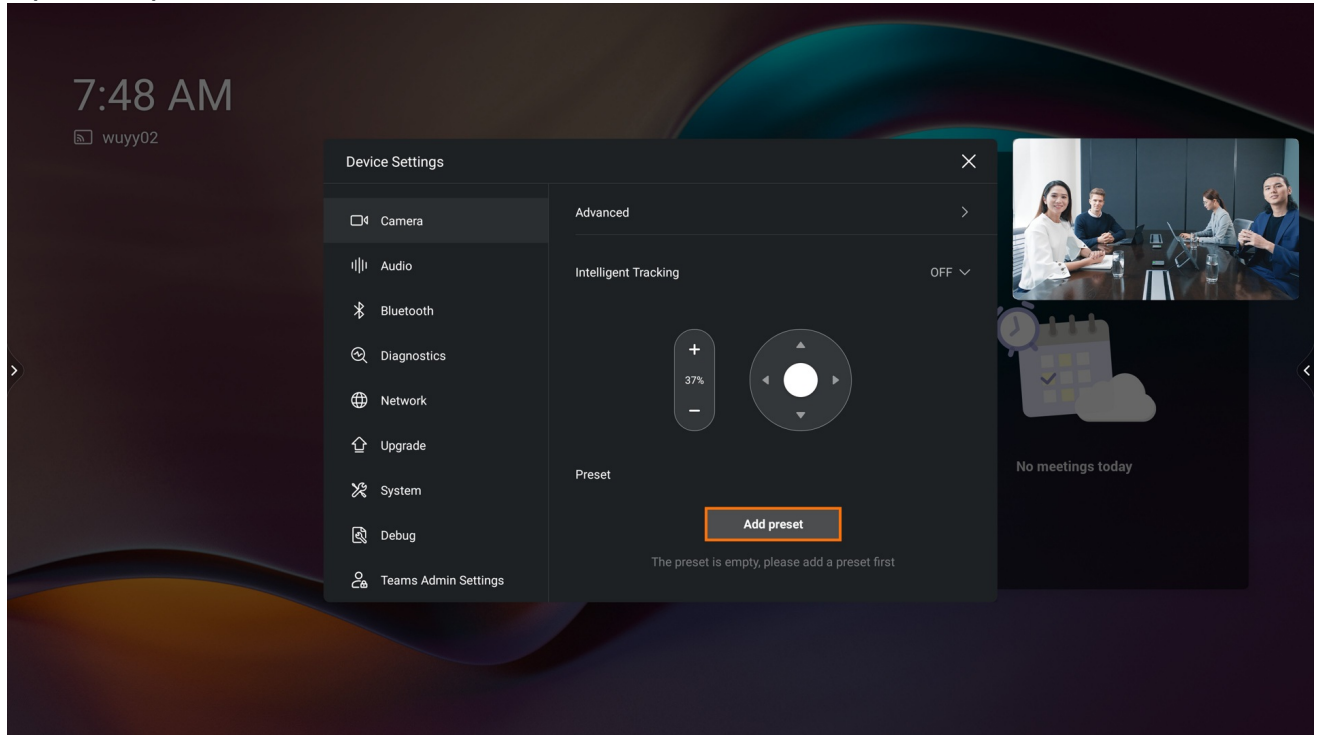



4. Edit Camera Preset Name

NOTE

During the meeting, you can edit the camera preset.

With the CTP18

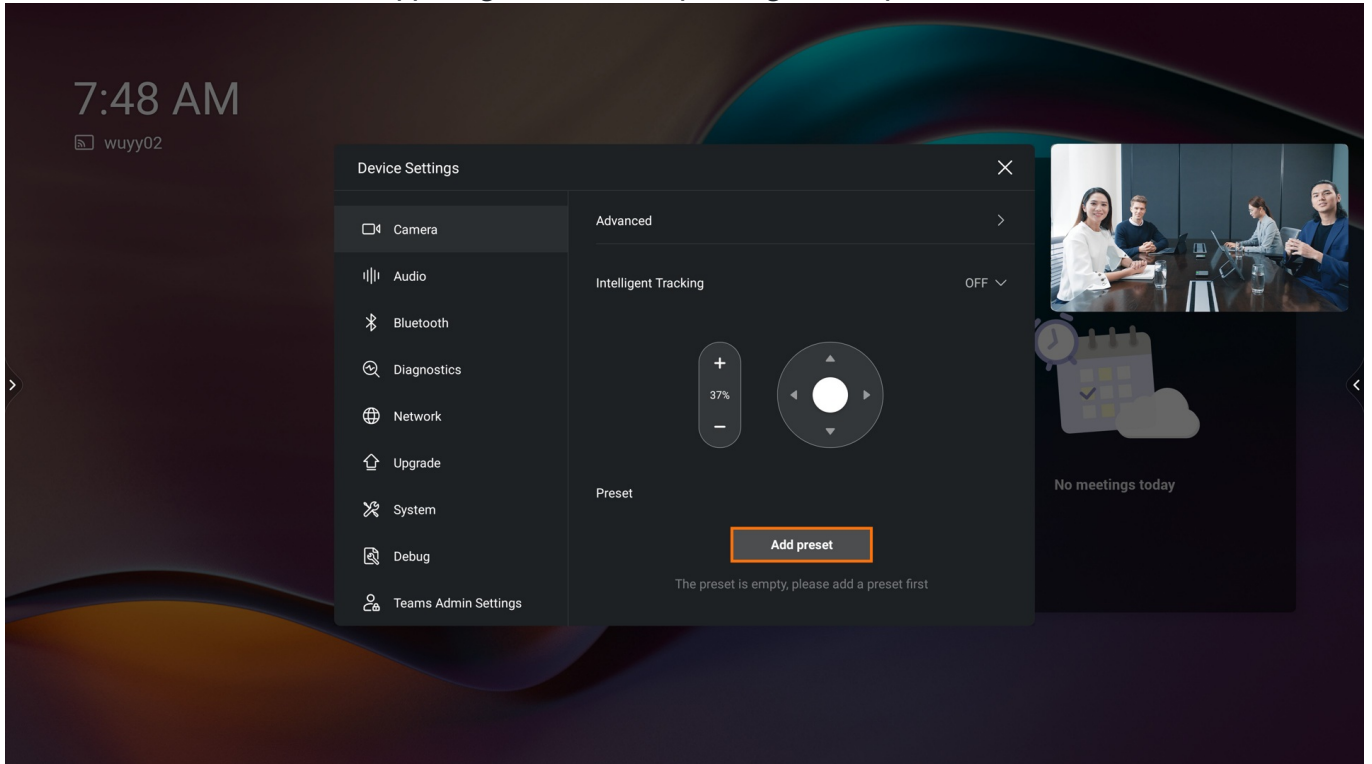

1. Before a meeting, go to  > **Camera Control** > **More**.
2. Tap **Camera Preview** to enable the camera to preview the camera effect.

3. Select  > **Edit Name** on the upper-right of the corresponding camera preset to edit.





5. Delete Camera Preset

- **With the Remote control**

1. Before a meeting, press and hold the Home  image.png button on VCR11 or the Teams  button on VCR20 for 5 seconds to bring up the sidebar.
2. Go to **Settings > Camera > Camera Settings**. Press the **OK** button on the remote control to open the menu and select **Preset**.
3. Select **Delete** on the right side of the corresponding camera preset to delete the corresponding camera preset.

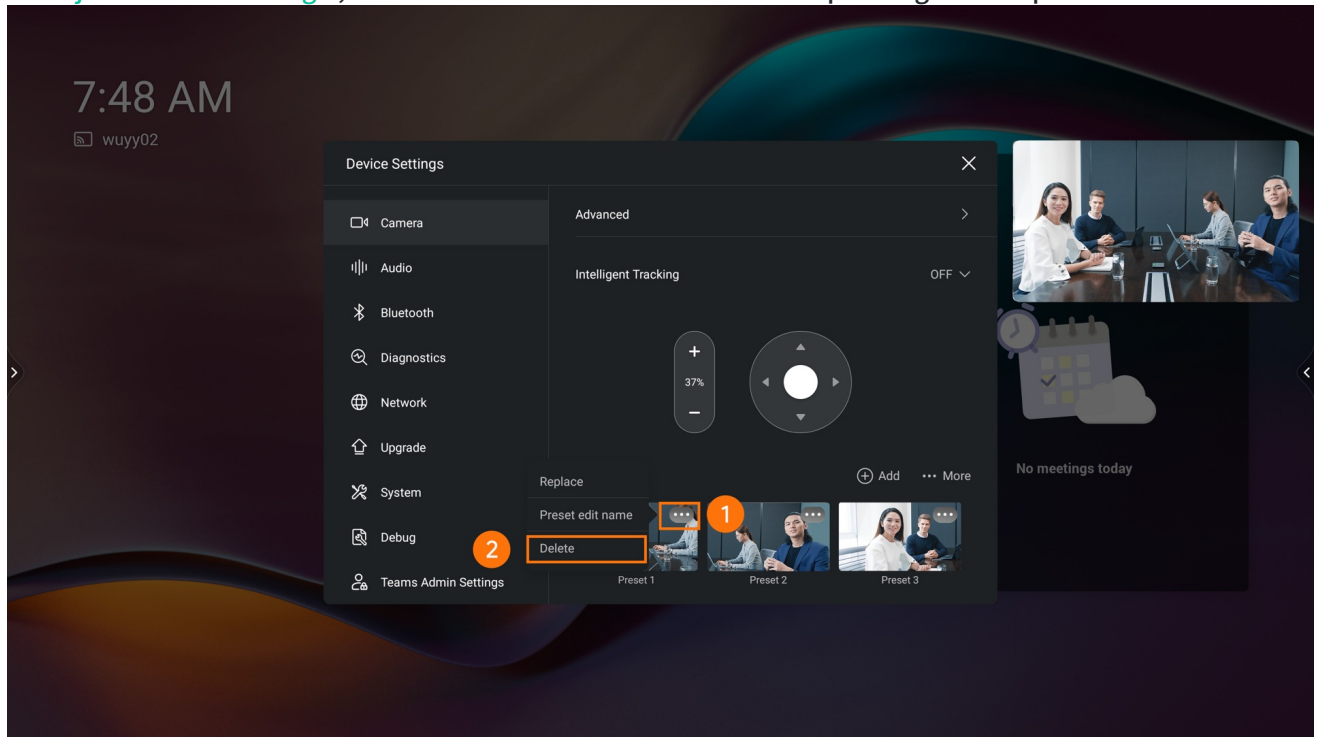

- **With the CTP18**

1. Before a meeting, go to  > **Camera Control** > **More**.
2. Tap **Camera Preview** to enable the camera to preview the camera effect.
3. To **adjust the camera angle**, select  > **Delete** to delete the corresponding camera preset.



6. Clear All Camera Preset

- **With the Remote control**

1. Before a meeting, press and hold the Home  image.png button on VCR11 or the Teams  button on VCR20 for 5 seconds to bring up the sidebar.
2. Go to **Settings** > **Camera** > **Camera Settings**. Press the **OK** button on the remote control to open the menu and select **Preset**.
3. Select  to clear all camera presets.

- **With the CTP18**

1. Before a meeting, go to  **Camera Control > More**.
2. Tap **More > Clear** to clear all camera presets.

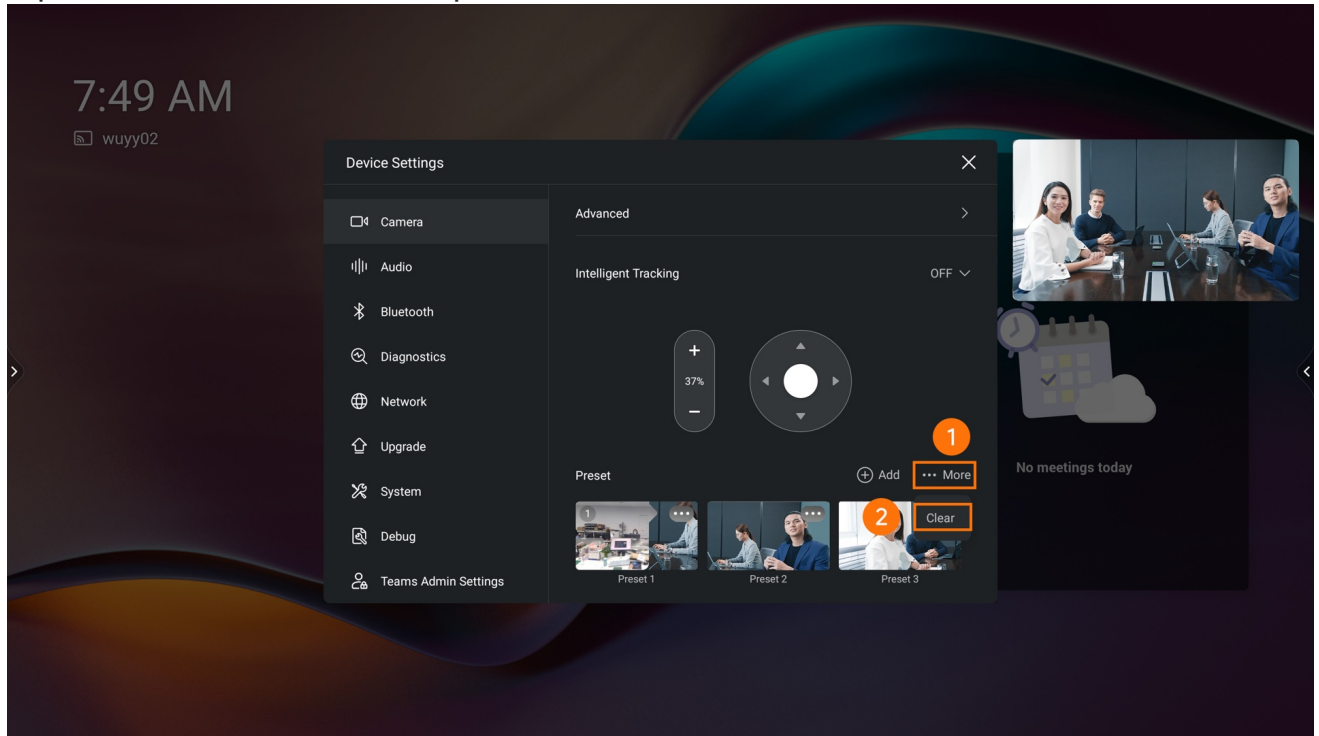

FAQ

What are the AI camera functions supported by MeetingBar A20/30?

Manual Controls

Introduction

Manually adjust the camera position before or during the meeting, and the position will take effect during the meeting.

For the operation video, please refer to [Control Manually](#).

NOTE

The camera cannot be adjusted manually in the Intelligent Tracking mode.

How to Use

Enter Camera Settings

- **With the Remote control**

During or before a meeting, press and hold the Home  button on VCR11 or the Teams  button on VCR20 for 5 seconds to bring up the sidebar, and select **Camera Control**.

- **With the CTP18**

During or before a meeting, go to  **Camera Control**.



NOTE

- You can use CTP18/VCR11/VCR20 to control MeetingBar A20/A30, and use CTP18/VCR11 to control MeetingBar A10.
- The default remote control is VCR11. If using VCR20 to operate, please make sure to configure the remote control as VCR20 on the web user interface. For more information, please refer to [Configure Remote Control](#).

2. Adjust Camera Angle

- **With the Remote control**

Press the arrow keys on the remote control to adjust the camera angle.

- **With the CTP18**
 1. Turn on the screen preview.
 2. Tap the arrow keys to adjust the camera angle.

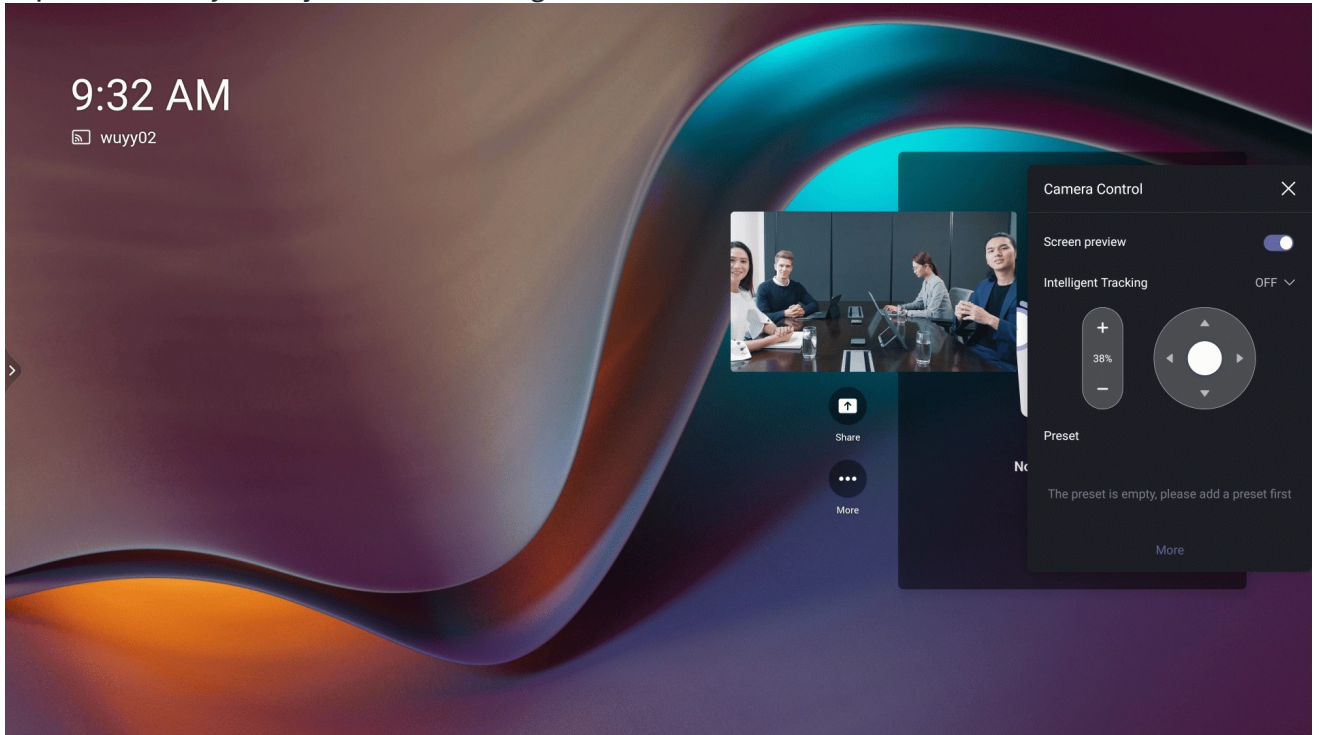

3. Adjust Camera Focus

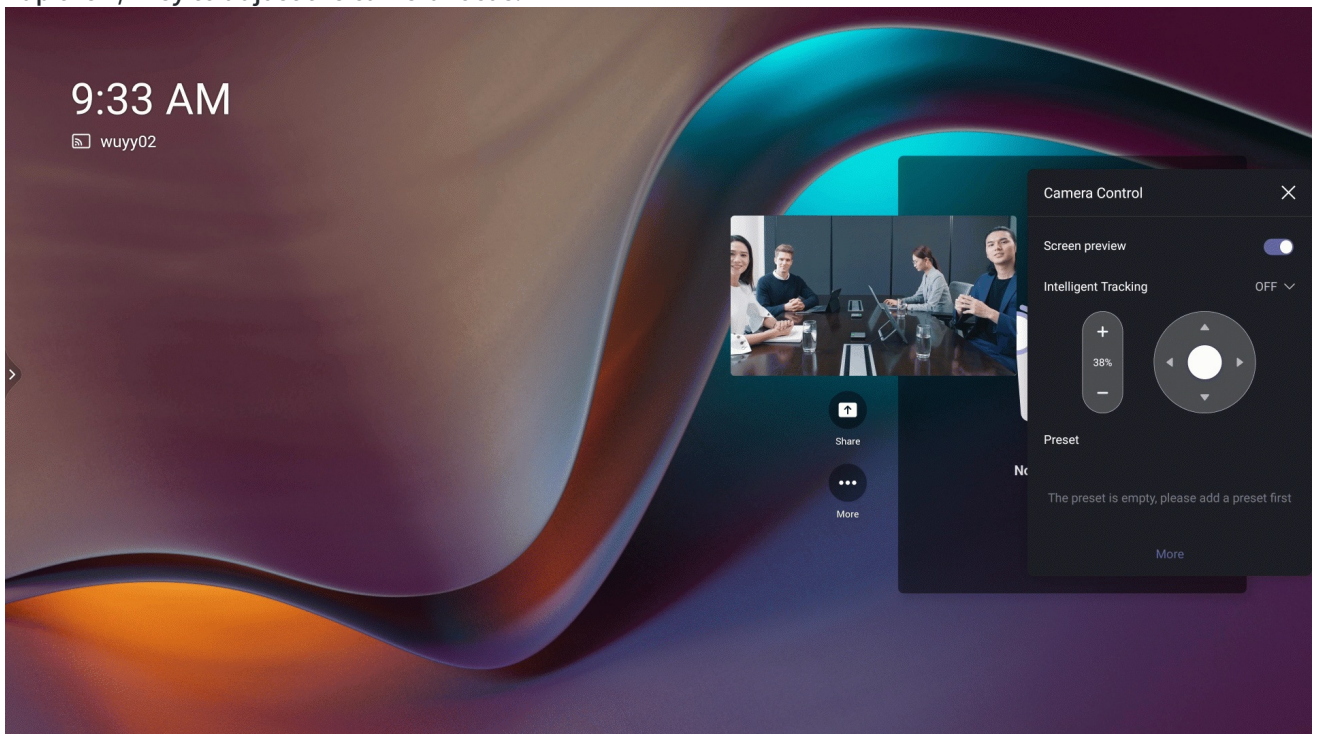

- **With the Remote control**

Press the +/- key on the remote control to adjust the camera focus.
- **With the CTP18**
 1. Turn on the screen preview.
 2. Tap the +/- key to adjust the camera focus.



4. Reset Camera

- **With the Remote control**

1. During or before a meeting, press and hold the Home  button on VCR11 or the Teams  button on VCR20 for 5 seconds to bring up the sidebar.
2. Select **Settings > Camera > Advanced Settings > Reset** to reset the camera to factory settings.

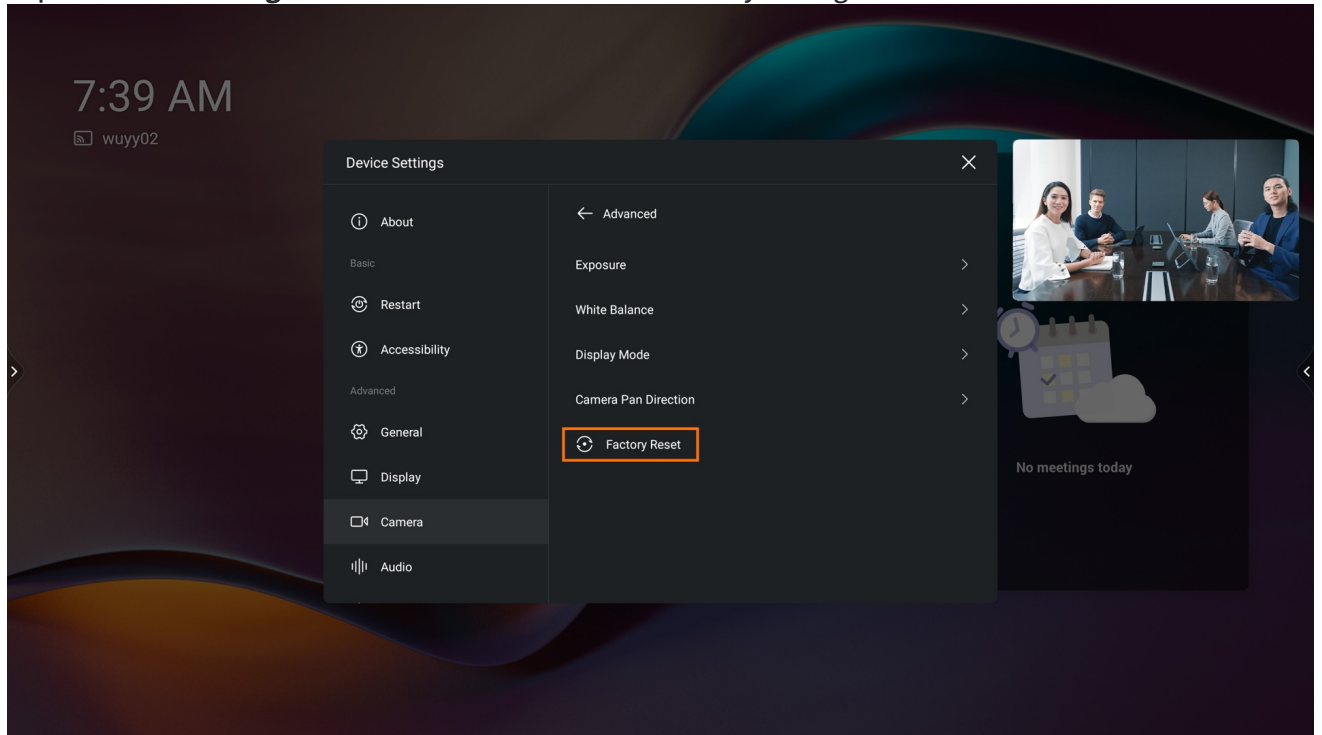

- **With the CTP18**

1. During or before a meeting, go to  **> Camera Control > More.**
2. Tap **Advanced Settings > Reset** to reset the camera to factory settings.



FAQ

Can not control the camera with VCR11/VCR20 before the meeting?

During the meeting, press and hold  button on the VCR11 or  button on the VCR20 for 5 seconds to bring up the sidebar and enter **Camera Control**. After setting, press **OK** key on the VCR11/VCR20 and select **Exit**.

Auto Framing

Introduction

Auto-framing is mainly based on face detection, which provides real-time detection and position tracking on all faces in the meeting room. The camera can be automatically adjusted based on changes in the number and location of participants.

For the operation video, please refer to [Auto Framing](#).

NOTE

- The camera cannot be adjusted manually in the Intelligent Tracking mode.
- You need to enter the web interface to set the tracking speed, please refer to [Camera Configuration](#).

Before You Begin

For better camera framing effects, please refer to [How to achieve better camera framing?](#)



How to Use

NOTE

- The default remote control is VCR11. If using VCR20 to operate, please make sure to configure the remote control as VCR20 on the web user interface. For more information, please refer to [Configure Remote Control](#).
- You can use CTP18/VCR11/VCR20 to control MeetingBar A20/A30, and use CTP18/VCR11 to control MeetingBar A10.

Disable/Enable Auto Framing

- **With the Remote control**

1. During or before a meeting, press and hold the Home  button on VCR11 or the Teams  button on VCR20 for 5 seconds to bring up the sidebar.
2. Press the **OK** button on the remote control to open the menu.
3. Go to **Intelligent Tracking > Auto Framing** to enable the Auto Framing.

- With the CTP18

During or before a meeting, go to  > **Camera Control** > **Intelligent Tracking** > **Auto Framing**.



Effect Demonstration



FAQ

Can I lock the layout of the AI mode or the screen sharing during a Teams meeting or call?

The AX0 does not support locking the layout of AI mode or screen sharing during a Teams meeting or call.

Speaker Tracking

Introduction

MeetingBar A10/A20/A30 (hereinafter referred to as MeetingBar AX0) supports the Speaker Tracking feature. Based on the Auto Framing feature, this feature can automatically detect the speaking participant and zoom in on his video image, providing an optimal close-up of the speaker. When two people speak in a meeting, the camera can focus on them simultaneously.

CTP18, VCR11, and VCR20 can be used to operate MeetingBar A20/A30, while CTP18 and VCR11 can be used to operate MeetingBar A10.

For the operation video, please refer to [Speaker Tracking](#).

NOTE

- The camera cannot be adjusted manually in the Intelligent Tracking mode.
- You need to enter the web interface to set the tracking speed, please refer to [Camera Configuration](#).

Before You Begin

For better camera framing effects, please refer to [How to achieve better camera framing?](#)



How to Use

NOTE

- The default remote control is VCR11. If using VCR20 to operate, please make sure to configure the remote control as VCR20 on the web user interface. For more information, please refer to [Configure Remote Control](#).
- You can use CTP18/VCR11/VCR20 to control MeetingBar A20/A30, and use CTP18/VCR11 to control MeetingBar A10.

Disable/Enable Speaker Tracking

• With the Remote control

1. During or before a meeting, press and hold the Home  button on VCR11 or the Teams  button on VCR20 for 5 seconds to bring up the sidebar.
2. Press the **OK** button on the remote control to open the menu.
3. Go to **Intelligent Tracking > Speaker Tracking** to enable the Speaker Tracking.

- With the CTP18

During or before a meeting, go to **< Camera Control > Intelligent Tracking > Speaker Tracking.**



Effect Demonstration



PiP Mode

Introduction

In the PiP Mode, it can realize the superimposed display of the speaker's close-up and the conference room's panoramic picture. The main window shows the view in the speaker tracking mode, and the small window shows the Auto Framing mode. When no one speaks, the window returns to the panoramic view.

For the operation video, please refer to [Picture in Picture](#).

NOTE

- It is only applicable to MeetingBar A20 and MeetingBar A30.
- The camera cannot be adjusted manually in the PiP mode.
- You need to enter the web interface to set the tracking speed, please refer to [Camera Configuration](#).



How to Use

NOTE

- The default remote control is VCR11. If using VCR20 to operate, please make sure to configure the remote control as VCR20 on the web user interface. For more information, please refer to [Configure Remote Control](#).
- You can use CTP18/VCR11/VCR20 to control MeetingBar A20/A30.

Disable/Enable PiP Mode

• With the Remote control

1. During or before a meeting, press and hold the Home  button on VCR11 or the Teams  button on VCR20 for 5 seconds to bring up the sidebar.
2. Press the **OK** button on the remote control to open the menu.
3. Go to **Intelligent Tracking > PiP Mode** to enable the PiP mode.

- With the CTP18

During or before a meeting, go to **< Camera Control > Intelligent Tracking > PiP Mode.**

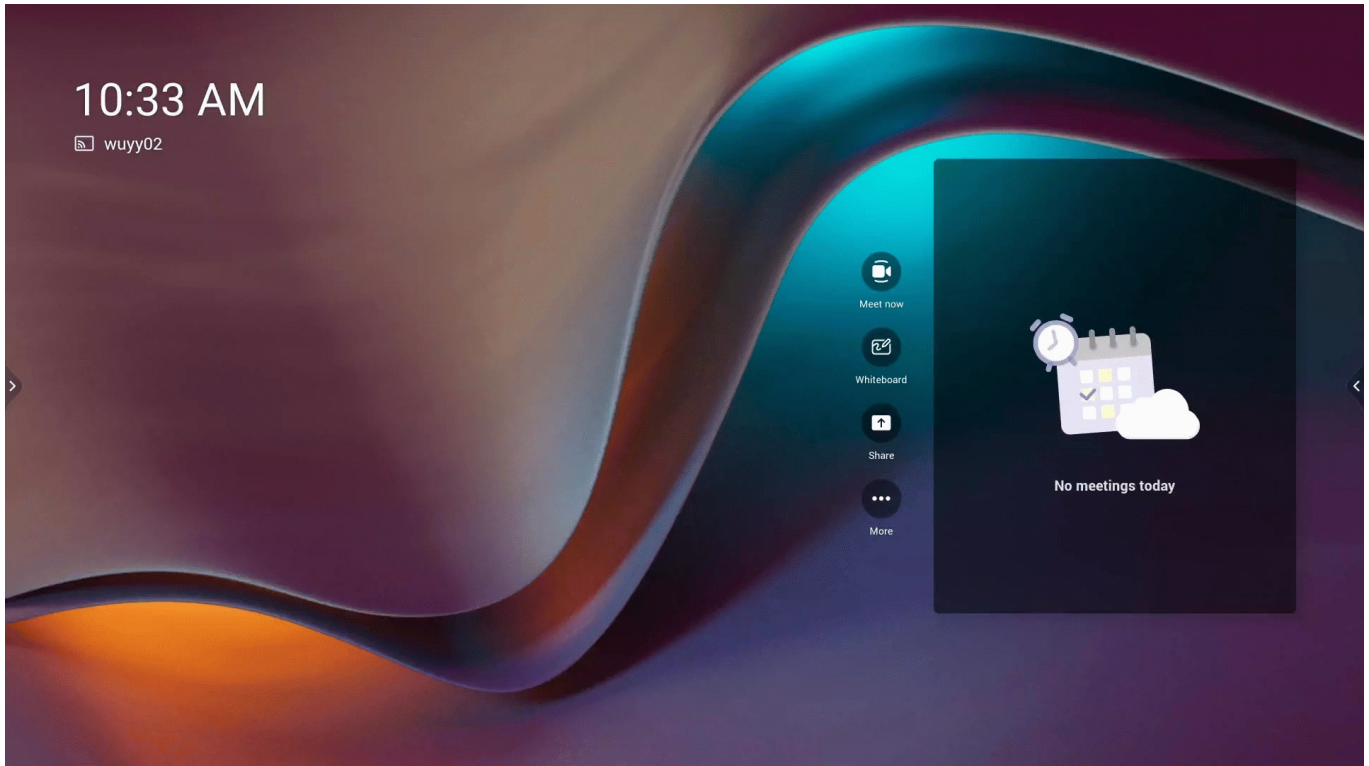

Effect Demonstration



Multi-focus

Introduction

For multi-person meetings, a separate close-up of each participant is cropped so that more participants appear on the screen and fully discuss with the other party, making the meeting more realistic.

This feature is applicable to horizontal meeting rooms and supports up to six split-screen images. The meeting image will switch to Auto Framing to display all participants when the split-screen image is more than six. To create a perfect video meeting experience, the distance between participants should be at least 30 cm.

For the operation video, please refer to [Multi-focus Framing](#).

NOTE

- The MeetingBar A20 and MeetingBar A10 (version 278.321.0.20 and later) supports Multi-focus mode, but MeetingBar A30 does not.
- The camera cannot be adjusted manually in the Multi-focus mode.

Before You Begin

For better camera framing effects, please refer to [How to achieve better camera framing?](#)



How to Use

NOTE

The default remote control is VCR11. If using VCR20 to operate, please make sure to configure the remote control as VCR20 on the web user interface. For more information, please refer to [Configure Remote Control](#).

Disable/Enable Multi-focus Framing

• With the Remote control

1. During or before a meeting, press and hold the Home  button on VCR11 or the Teams  button on VCR20 for 5 seconds to bring up the sidebar.
2. Press the **OK** button on the remote control to open the menu.
3. Go to **Intelligent Tracking > Multi-focus** to enable the Multi-focus mode.

- With the CTP18

During or before a meeting, go to **<** > **Camera Control > Intelligent Tracking > Multi-focus.**

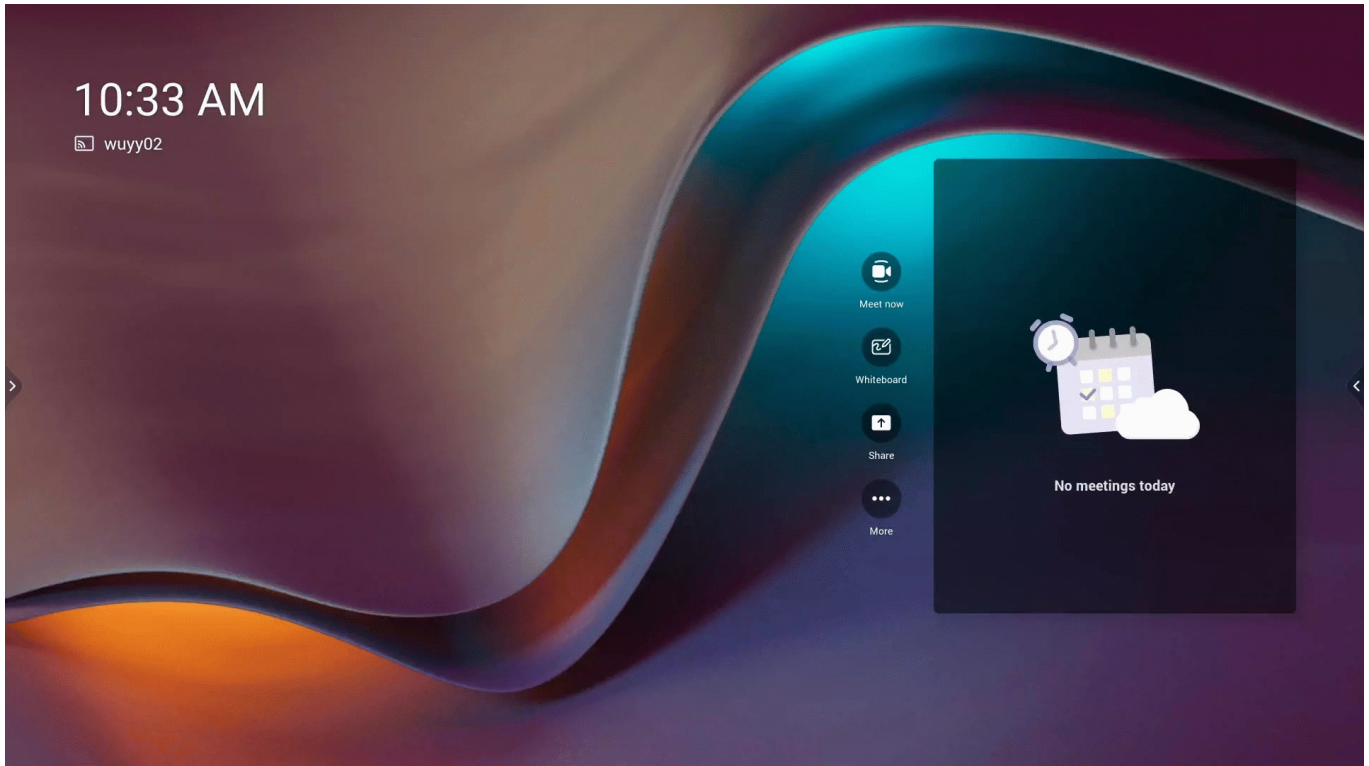

Effect Demonstration



Small FoV Mode

Introduction

Small FoV Mode supports cropping the camera image into a different field of view to display the image more concentratedly.

For the operation video, please refer to [Small FoV Mode](#).

NOTE

- The camera cannot be adjusted manually in the Small FoV mode.
- It is only applicable to MeetingBar A10 and MeetingBar A20.
- You need to enter the web interface to set the tracking speed, please refer to [Camera Configuration](#).



How to Use

NOTE

- The default remote control is VCR11. If using VCR20 to operate, please make sure to configure the remote control as VCR20 on the web user interface. For more information, please refer to [Configure Remote Control](#).
- You can use CTP18/VCR11/VCR20 to control MeetingBar A20/A30, and use CTP18/VCR11 to control MeetingBar A10.

Disable/Enable Small FoV Mode

• With the Remote control

1. During or before a meeting, press and hold the Home  button on VCR11 or the Teams  button on VCR20 for 5 seconds to bring up the sidebar.
2. Press the **OK** button on the remote control to open the menu.
3. Go to **Intelligent Tracking > Small FoV Mode** to enable the Small FoV mode.

• With the CTP18

During or before a meeting, go to  **> Camera Control > Intelligent Tracking > Small FoV Mode**.

Effect Demonstration

Small FoV Mode



90°



70°

FAQ

[How to enter the Small FoV Mode on the MeetingBar A20?](#)

Accessories

VCM34 Array Microphone

Introduction

VCM34 is a video conferencing microphone array that can work as the audio input device for Yealink Video Conferencing System or Yealink UVC PTZ Camera to match more meeting room scenarios and reduce installation costs. With a built-in 3-microphone array and superior audio technology, VCM34 owns a 20ft (6 m) and 360° voice pickup range, regarded as an ideal solution for any conference room that needs the best audio experience. VCM34 supports PoE, which enables simple and easy deployment. In this way, power supply data transmission and signal control unify as one, sharply reducing the complex installation procedures and the costly expenses.

For the operation video, please refer to [VCM34](#).

VCM34 Compatibility

For the VCM34 compatibility, please refer to [Teams Room Accessories Compatibility Lists](#).

How to Use

Connect VCM34 to MeetingBar A20/A30

1. Remove the rear cover of VCM34

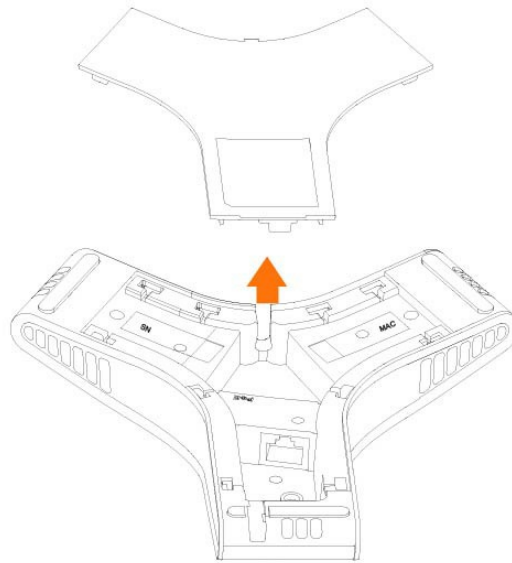

2. Connect VCM34 to MeetingBar A20/A30

NOTE

The following takes the connection between MeetingBar A30 and VCM34 as an example.

Connect a VCM34

Use a network cable to connect the VC Hub/Phone port of the MeetingBar A20/A30 to the PoE port of the VCM34.

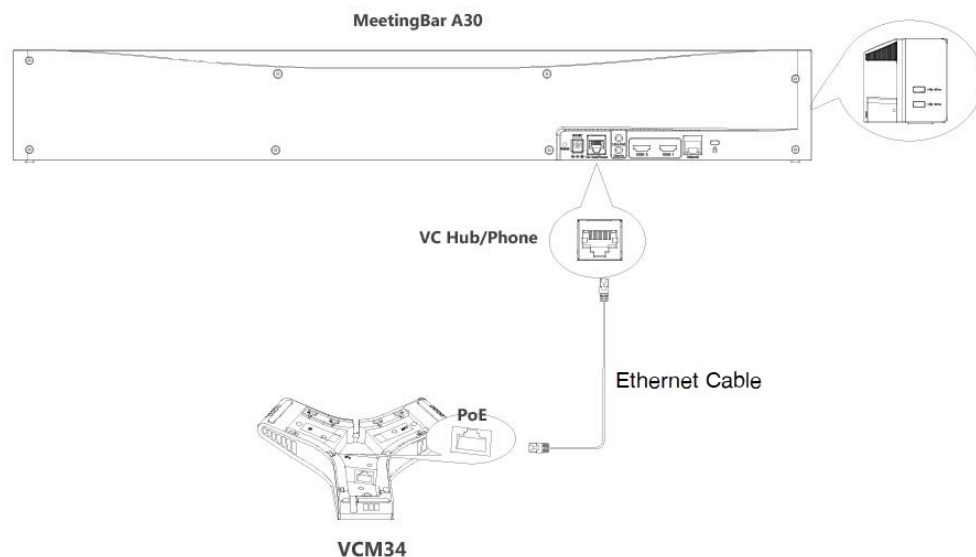

Connect multiple VCM34

Use a network cable to connect the VC Hub/Phone port of the MeetingBar A20/A30 to the PoE port of the VCM34. Connect the other port of VCM34 to the PoE port of other VCM34 via a network cable to realize cascading of multiple VCM34.

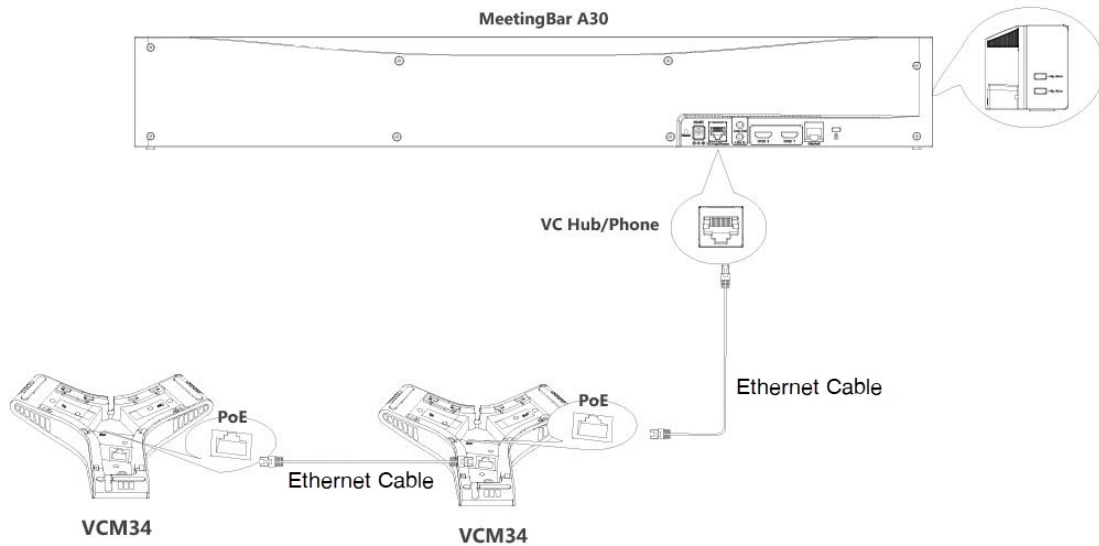

Connect VCM34 and VCH51 simultaneously

You can simultaneously connect VCM34 and VCH51 to MeetingBar A20/A30 through the PoE switch.

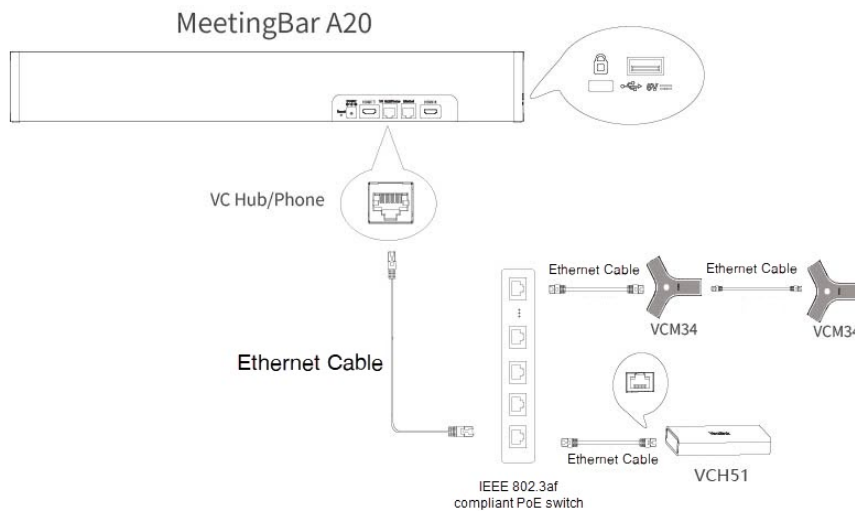

Mute/Unmute Microphone

Please refer to: [Mute/Unmute Microphone](#).

Audio Settings

If you want to manually set the specified audio input device after connecting the VCM34 to the MeetingBar A20/A30, please refer to [Audio Settings](#).

Update VCM34

The VCM34 automatically obtains the ROM package from the MeetingBar A20/A30. If you need to use the latest version of VCM34 firmware, please update the MeetingBar A20/A30 to the latest version. For more information, please refer to [Firmware Update](#). The VCM34 does not support individual updates.

FAQ

Failed to connect MeetingBar A20/A30 to VCM34.

Can VCM34 and the built-in microphone of the MeetingBar A20/A30 pick up sound at the same time?

The VCM34 is an external microphone and does not support picking up sound with the built-in microphone simultaneously. For more information about the sound pickup of the built-in microphone and external microphone, please refer to [Can the built-in microphone and external microphone pick up sound at the same time?](#)

After connecting MeetingBar A20/A30 to the VCM34, the VCM34 cannot pick up the audio/there is no response when touching the VCM34 mute button.

The MeetingBar A10/A20/A30 does not support using multiple microphone devices simultaneously. Please check whether other microphones are connected at the same time. For more information, please refer to [Does the MeetingBar AX0 support multiple microphone devices at the same time?](#)

How to reset the VCM34 microphone?

The VCM34 microphone does not support being factory reset. If there is a problem with the VCM34, please refer to [VCM34 Troubleshooting](#).

VCM38 Ceiling Microphone

Introduction

VCM38 is a newly designed ceiling microphone with 8 built-in microphones for 360-degree voice pickup. VCM38 delivers excellent voice quality with high-quality echo cancellation and Yealink noise-proof technology. With Beamforming technology, VCM38 can automatically locate and optimize voice pick-up for the person speaking. A single VCM38 unit can cover 40 square meters, even for oversized meeting rooms by using up to eight VCM38 units in one system.

VCM38 supports PoE, which enables simple and easy deployment. It can be installed directly on the ceiling or by a telescopic rod that can be adjusted between 30 - 60 cm to keep the room table clean and match more meeting room scenarios.

For the operation video, please refer to [VCM38](#).

VCM38 Compatibility

For the VCM38 maximum number of compatible devices that can be connected to MeetingBar AX0, please refer to [Teams Room Accessories Compatibility Lists](#).

How to Use

Installation

VCM38 can be suspended on the ceiling or hung on the ceiling. For more information, please refer to [VCM38](#).

Connect VCM38 to MeetingBar A20/A30

Connect a VCM38

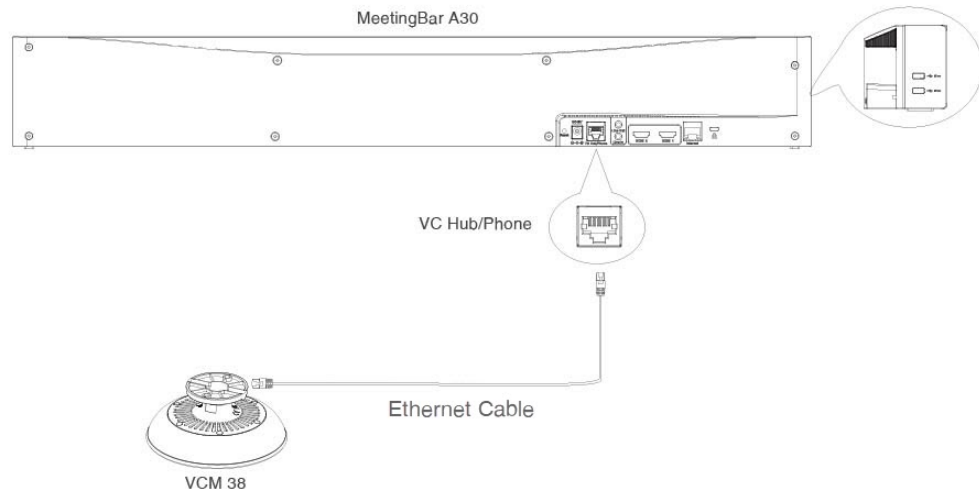

Connect multiple VCM38

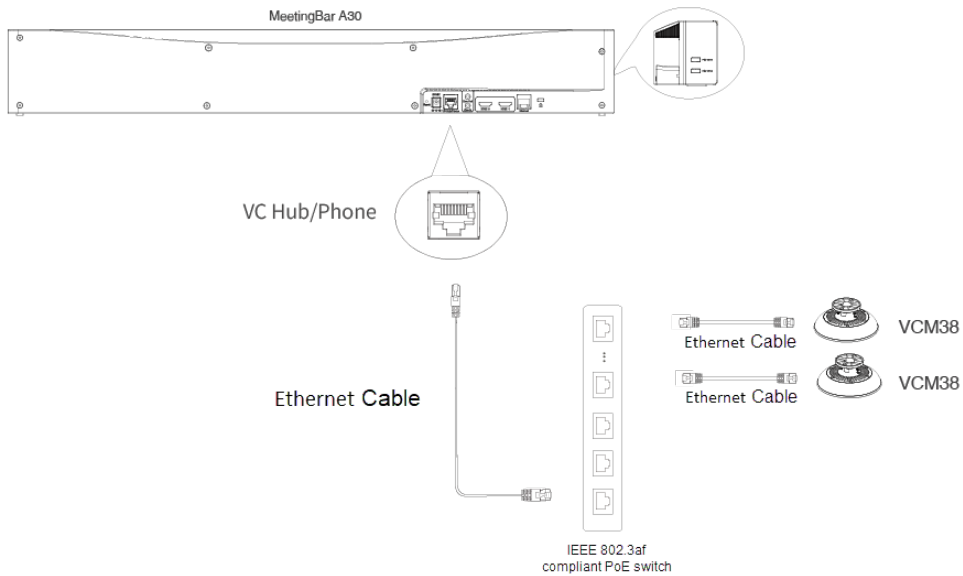

Connect VCM38 and VCH51 simultaneously

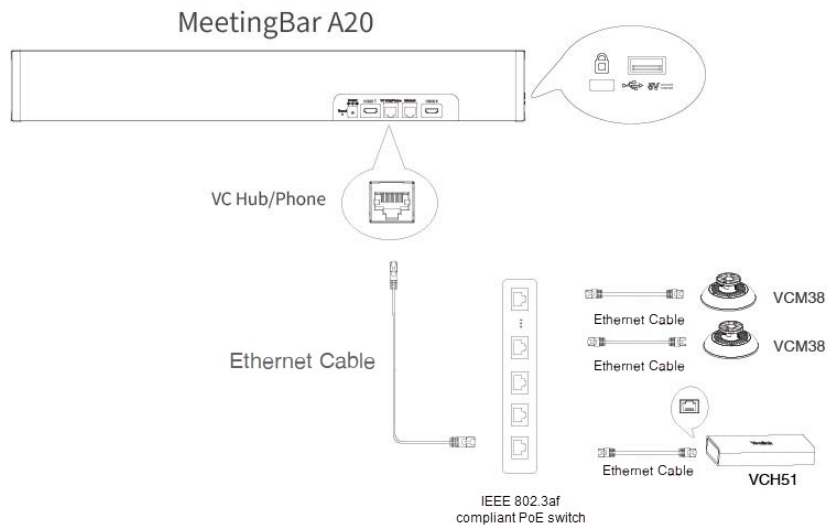

Mute/Unmute Microphone

Please refer to: [Mute/Unmute Microphone](#).

Audio Settings

If you want to manually set the specified audio input device after connecting the VCM38 to the MeetingBar A20/A30, please refer to [Audio Settings](#).

Update VCM38

The VCM38 automatically obtains the ROM package from the MeetingBar A20/A30. If you need to use the latest version of VCM38 firmware, please update the MeetingBar A20/A30 to the latest version. For more information, please refer to [Firmware Update](#). The VCM38 does not support individual updates.

FAQ

Failed to connect MeetingBar A20/A30 to VCM38.

Can VCM38 and the built-in microphone of the MeetingBar A20/A30 pick up sound at the same time?

The VCM38 is an external microphone and does not support picking up sound with the built-in microphone simultaneously. For more information about the sound pickup of the built-in microphone and external microphone, please refer to [Can the built-in microphone and external microphone pick up sound at the same time?](#)

How to reset the VCM38 microphone?

The VCM38 microphone does not support reset. If there is a problem with the VCM38, please refer to [VCM38 Troubleshooting](#).

VCM36-W Wireless Microphone

Introduction

The Yealink VCM36-W is an innovative wireless video conferencing microphone designed to accommodate a wide range of meeting room needs. With a built-in 3-microphone array, the VCM36-W has a 20ft (6m) and 360° voice pickup range. It features Yealink's high-quality echo cancellation technology and noise cancellation, effectively filtering out up to 90dB of ambient noise to provide a high-quality audio experience during full-duplex calls. The VCM36-W's high-quality pickup technology enables it to provide a full range of audio coverage for all sizes of conference rooms. The VCM36-W is easy to use with a single pairing, with up to 12 hours of battery life in conference mode and 7 days of standby time. The VCM36-W WIFI microphone is equipped with a charging dock that allows you to charge the microphone wirelessly, and you can change its deployment position at any time while using it to suit your needs.

For the operation video, please refer to [VCM36-W](#).

VCM36-W Compatibility

For the VCM36-W compatibility, please refer to [Teams Room Accessories Compatibility Lists](#).

How to Use

Overview

Please refer to: [VCM36-W Hardware Introduction](#).

Charge

Please refer to: [VCM36-W Charge](#).

Power On and Off

Please refer to: [Power On and Off](#).

Connect VCM36-W to MeetingBar A20/A30

NOTE

- The following takes the connection between the MeetingBar A30 and VCM36-W as an example.
- To pair VCM36-W with MeetingBar AX0, enable the Wireless AP. Go to **More > Settings > Device Settings > Network (default password: 0000) > Wireless AP**, and enable the **Wireless AP**. After enabling the **Wireless AP**, the Wi-Fi is automatically disabled.

Use a USB cable (A-C) to connect VCM36-W and MeetingBar A20/A30.

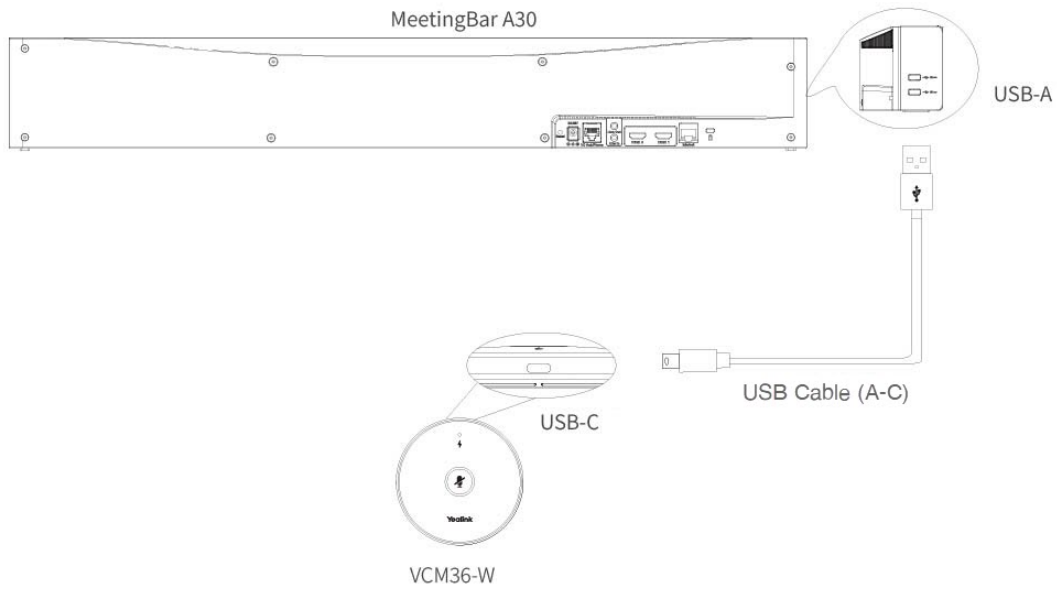

On the CTP18 or with the remote control, go to **More > Settings > Device Settings > Audio > Wireless Microphone** to view the connected VCM36-W.

After disconnecting the USB cable (A-C), the VCM36-W can be used normally.

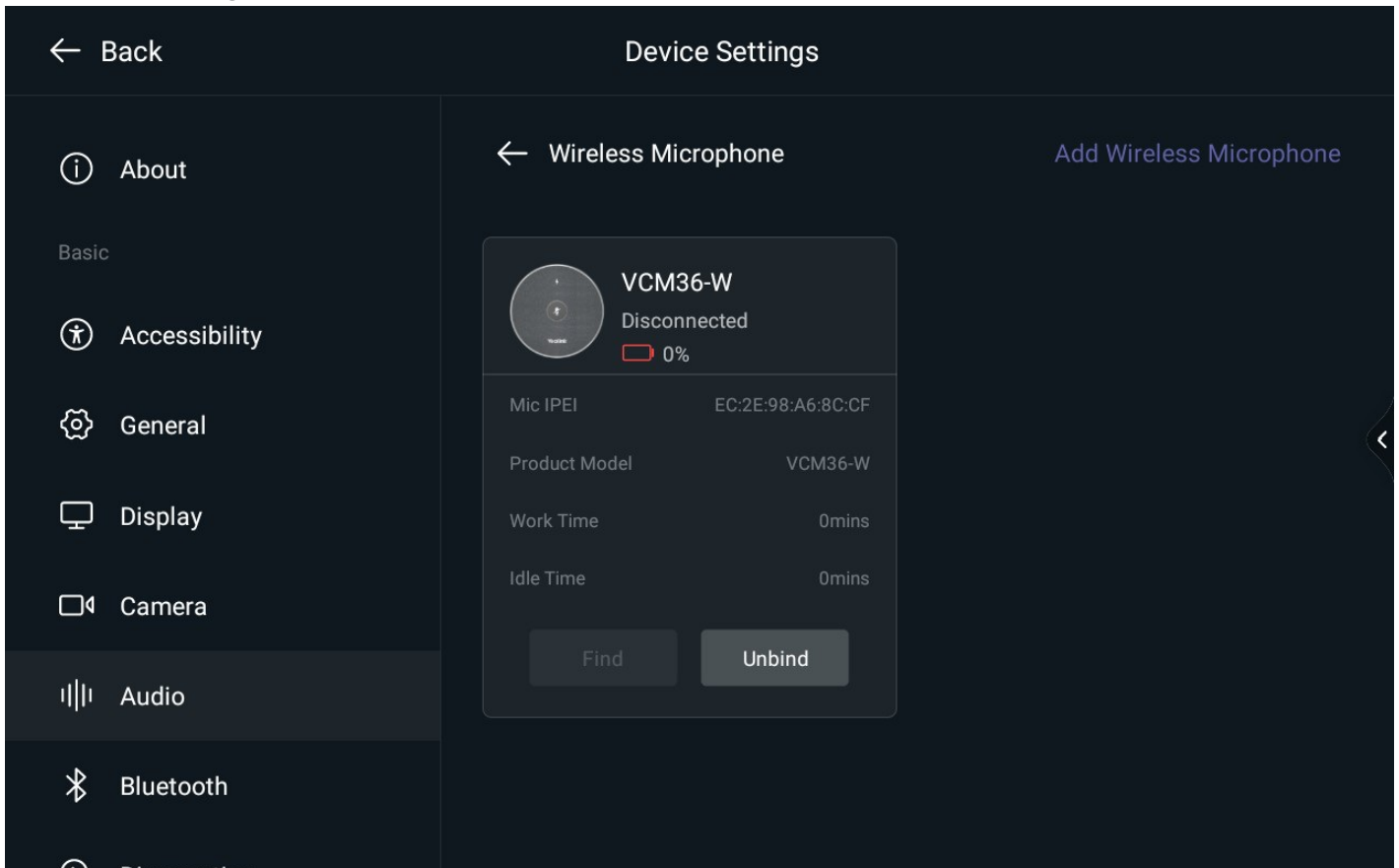

Unbinding VCM36-W (A20/A30)

On the CTP18 or with the remote control, go to **More > Settings > Device Settings > Audio > Wireless Microphone** to unbind the connected VCM36-W.

LED Indicator

Please refer to: [VCM36-W LED Indicator](#).

Mute/Unmute Microphone

Please refer to: [Mute/Unmute Microphone](#).

Audio Settings

If you want to set audio input manually after pairing, please refer to: [Audio Settings](#).

Update VCM36-W

NOTE

Make sure the VCM36-W has enough power before upgrading.

After pairing the VCM36-W to the MeetingBar A20/A30, the built-in firmware will be obtained from the MeetingBar A20/A30. For more information, please refer to [Firmware Update](#). If the VCM36-W upgrade fails, you can download the VCM36-W firmware manually. For more information, please refer to [FAQ](#).

FAQ

Failed to connect MeetingBar A20/A30 to VCM36-W.

Does MeetingBar A20/A30 support use WPP20/WPP30 and VCM36-W simultaneously?

Can VCM36-W and the built-in microphone of the MeetingBar A20/A30 pick up sound at the same time?

The VCM36-W is an expansion microphone that supports simultaneously picking up sound with the built-in microphone. The meeting will automatically select the VCM36-W or the built-in microphone of A20/A30 to pick up sound according to the position of the sound source. For more information about the sound pickup of the built-in microphone and external microphone, please refer to [Can the built-in microphone and external microphone pick up sound at the same time?](#)

After connecting MeetingBar A20/A30 to the VCM36-W, the VCM36-W cannot pick up the audio/there is no response when touching the VCM36-W mute button.

The MeetingBar A10/A20/A30 does not support using multiple microphone devices simultaneously. Please check whether other microphones are connected at the same time. For more information, please refer to [Does the MeetingBar AX0 support multiple microphone devices at the same time?](#)

How to reset the VCM36-W microphone?

The VCM36-W microphone does not support reset. If there is a problem with the VCM36-W, please refer to [VCM36-W Troubleshooting](#).

CPW90 Wireless Microphone

Introduction

Yealink CPW90 is a wireless expansion microphone that supports 360° omnidirectional sound pickup with a pickup radius of 3 meters, bringing you the ultimate high-definition audio experience.

For the operation video, please refer to [CPW90](#).

CPW90 Compatibility

For the CPW90 compatibility, please refer to [Teams Room Accessories Compatibility Lists](#).

How to Use

Connect CPW90 to MeetingBar A20/A30

1. Connect DD10 USB Dongle to MeetingBar A20/A30

1. Power on CPW90 via the Micro-USB cable and power adapter.
2. Insert DD10 USB Dongle into the USB-A port of the MeetingBar A20/A30.
3. The display connected to the MeetingBar A20/A30 will prompt **Wireless microphone adapter is connected**.

Take the MeetingBar A20 as an example.

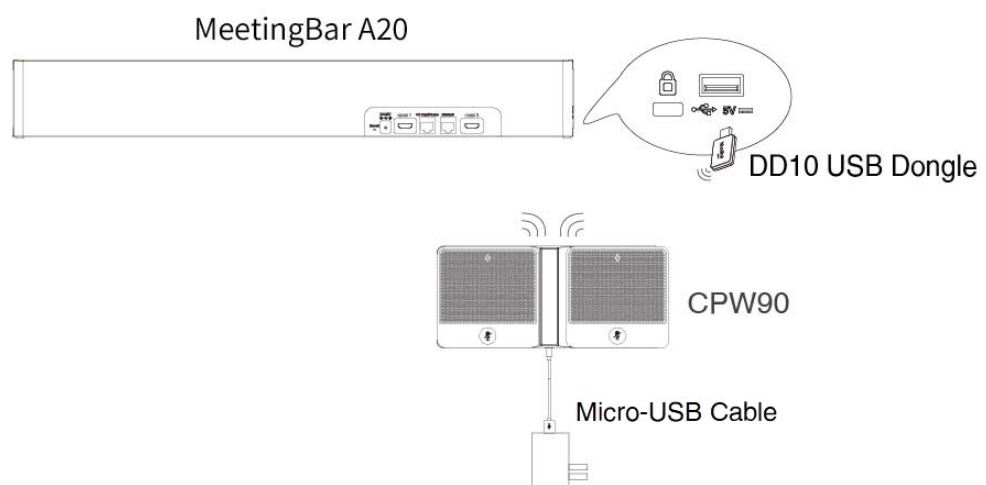

2. Pair CPW90 with MeetingBar A20/A30

On the CTP18 or with the remote control, go to **More > Settings > Device Settings > Audio > Wireless Microphone**

to select **Add CPW90**.

Press and hold the mute button on CPW90 for 5s until the mute indicator flashes yellow quickly.

The MeetingBar AX0 is successfully connected to CPW90. Check the connected microphone to unbind or search the microphone.

LED Indicator

Please refer to: [CPW90 LED Indicator](#).

Mute/Unmute Microphone

Please refer to: [Mute/Unmute Microphone](#).

Audio Settings

If you want to manually set the specified audio input device after connecting the CPW90 to the MeetingBar A20/A30, please refer to [Audio Settings](#).

Update CPW90

The CPW90 does not support updates.

FAQ

Failed to connect MeetingBar A20/A30 to CPW90.

Can CPW90 and the built-in microphone of the MeetingBar A20/A30 pick up sound at the same time?

The CPW90 is an external microphone and does not support picking up sound with the built-in microphone simultaneously. For more information about the sound pickup of the built-in microphone and external microphone, please refer to [Can the built-in microphone and external microphone pick up sound at the same time?](#)

After connecting MeetingBar A20/A30 to the CPW90, the CPW90 cannot pick up the audio/there is no response when touching the CPW90 mute button.

The MeetingBar A10/A20/A30 does not support using multiple microphone devices simultaneously. Please check whether other microphones are connected at the same time. For more information, please refer to [Does the MeetingBar AX0 support multiple microphone devices at the same time?](#)

How to reset the CPW90 microphone?

The CPW90 microphone does not support reset. If there is a problem with the CPW90, please refer to [CPW90 Troubleshooting](#).

VCM35 Video Conferencing Microphone

Introduction

Yealink VCM35 is a wired video conferencing microphone array specially designed for the generation of the new Yealink Video Conferencing System. Its built-in 3-microphone array with a 20ft (6 m) and 360° voice pickup range is an ideal solution for any conference room with the best audio experience. With the Yealink Acoustic Echo Canceling and Yealink Noise Proof Technology, Yealink VCM35 can effectively reduce ambient noise up to 90 dB and give you a high-quality audio experience in full-duplex calls. Yealink VCM35 supports star-cascaded deployment, and its extremely high scalability and flexibility make deployment more convenient and faster and can fully cover conference rooms of various sizes.

VCM35 Compatibility

For the VCM35 compatibility, please refer to [Teams Room Accessories Compatibility Lists](#).

How to Use

Connect VCM35 to MeetingBar A20/A30

- **Connect a VCM35**

Connect VCM35 to the VCH Port of MeetingBar AX0. The display prompts **Mic array connection**.

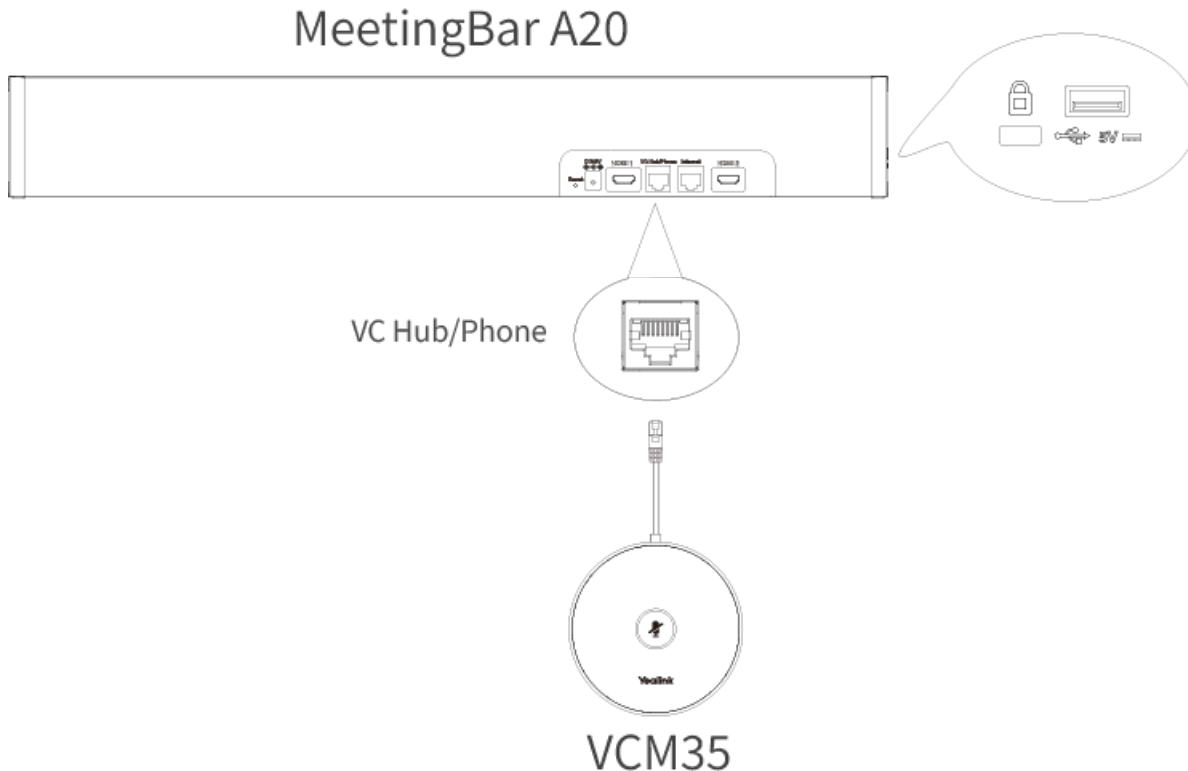

Connect multiple VCM35

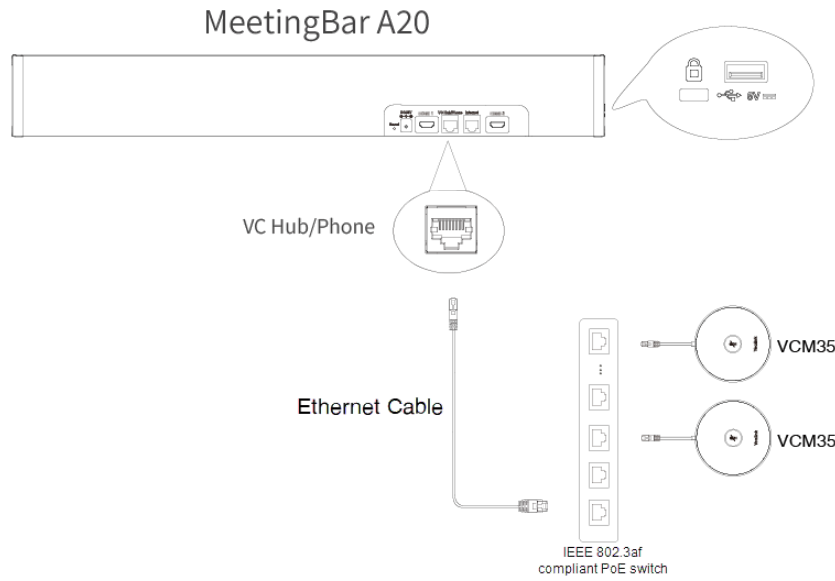

- **Connect VCM35 and VCH51 simultaneously**

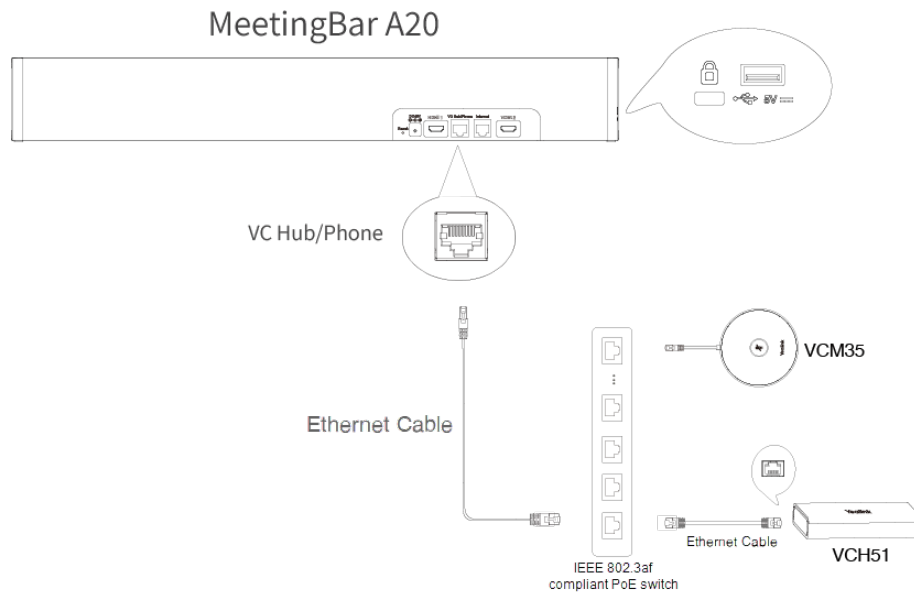

LED Indicator

Please refer to: [VCM35 LED Indicator](#).

Mute/unmute Microphone

Please refer to: [Mute/Unmute Microphone](#).

Audio Settings

If you want to manually set the specified audio input device after connecting the VCM35 to the MeetingBar A20/A30, please refer to [Audio Settings](#).

Update VCM35

The VCM35 automatically obtains the ROM package from the MeetingBar A20/A30. If you need to use the latest version of VCM35 firmware, please update the MeetingBar A20/A30 to the latest version. For more information, please refer to [Firmware Update](#). The VCM35 does not support individual updates.

FAQ

Failed to connect MeetingBar A20/A30 to VCM35.

Can VCM35 and the built-in microphone of the MeetingBar A20/A30 pick up sound at the same time?

When using VCM35 with A20/A30, it functions as an external microphone and does not support picking up sound with the built-in microphone simultaneously.

For more information about the sound pickup of the built-in microphone and external microphone, please refer to [Can the built-in microphone and external microphone pick up sound at the same time?](#)

After connecting MeetingBar A20/A30 to the VCM35, the VCM35 cannot pick up the audio/there is no response when touching the VCM35 mute button.

The MeetingBar A10/A20/A30 does not support using multiple microphone devices at the same time. Please check whether other microphones are connected at the same time. For more information, please refer to [Does the MeetingBar AX0 support multiple microphone devices at the same time?](#)

How to reset the VCM35 microphone?

The VCM35 microphone does not support reset. If there is a problem with the VCM35, please refer to [VCM35 Troubleshooting](#).

CTP18 Touch Panel

Introduction

CTP18 is a collaboration touch panel that can be paired with video conferencing endpoints. Its 8-inch touch panel and native Teams or Zoom controller experience allow users to join or control a meeting quickly and effortlessly. It greatly reduces the difficulty of using a video conferencing system and creates a better meeting experience.

Cooperating with Microsoft Teams or Zoom, CTP18 can be paired with video conferencing endpoints and configured with the paired device, making the meeting more communicative and collaborative.

For the operation video, please refer to [CTP18](#).

CTP18 Compatibility

For the CTP18 compatibility, please refer to [Teams Room Accessories Compatibility Lists](#).

How to Use

Install CTP18

After CTP18 is assembled, it can be placed on the desktop or installed on the wall. For more information, please refer to [CTP18](#).

Connect CTP18

Connect CTP18 via PoE

NOTE
The CTP18 and MeetingBar A10/A20/A30 need to be under the same LAN.

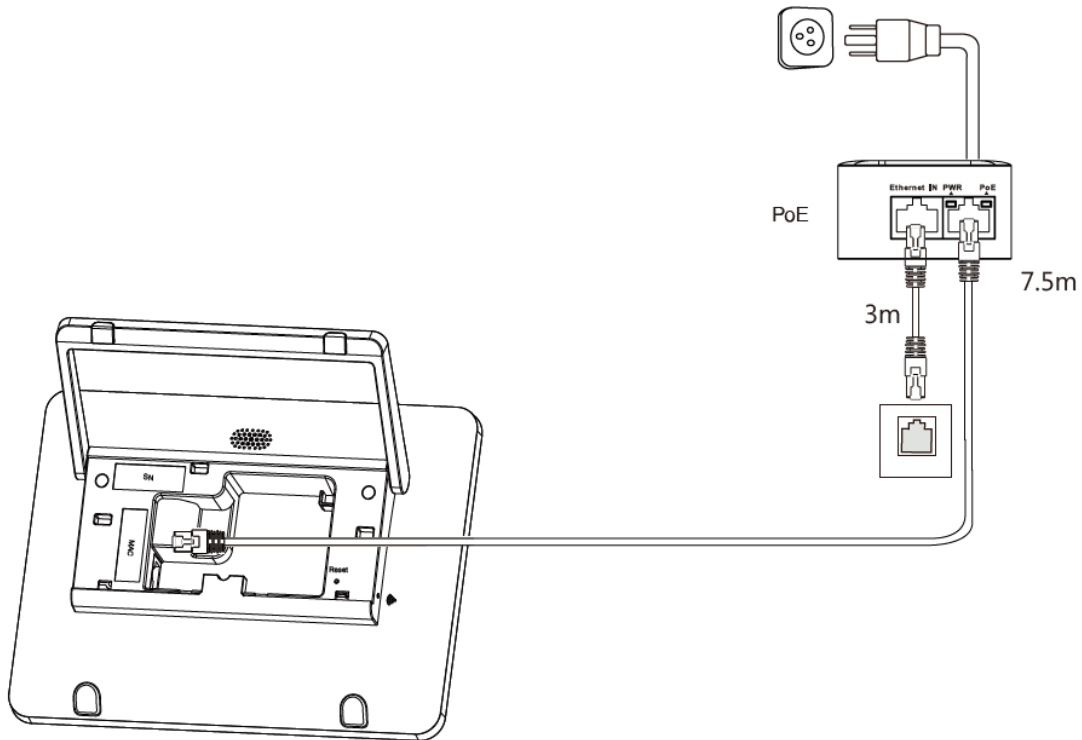

CTP18 Deployment Mode

After enabling the deployment mode of MeetingBar A20/A30, the CTP18 can be directly connected to the VC Hub/Phone port of MeetingBar A20/A30 with a network cable.

NOTE

- MeetingBar A20/A30 versions 133.320.0.12 and later support the deployment mode, but the MeetingBar A10 does not support it.
- MeetingBar A20/A30 is connected via a wired network. If MeetingBar AX0 uses WIFI in deployment mode, CTP18 cannot obtain the network.
- MeetingBar A20/A30 has completed the initial configuration (configure language, network, time zone, automatic update, and platform selection). For more information, please refer to Quick Setup.

1. Enable/disable Deployment Mode

1. Enter the IP address of MeetingBar A20/A30 in the browser, for example, <https://10.50.56.1/> and press Enter.
2. Enter the user name and password (default user name: admin; default password: 0000).
3. Go to **System > Advanced Features** on the web user interface.
4. Enable **Deployment Mode** and click **Submit**. It takes effect after the device restarts.

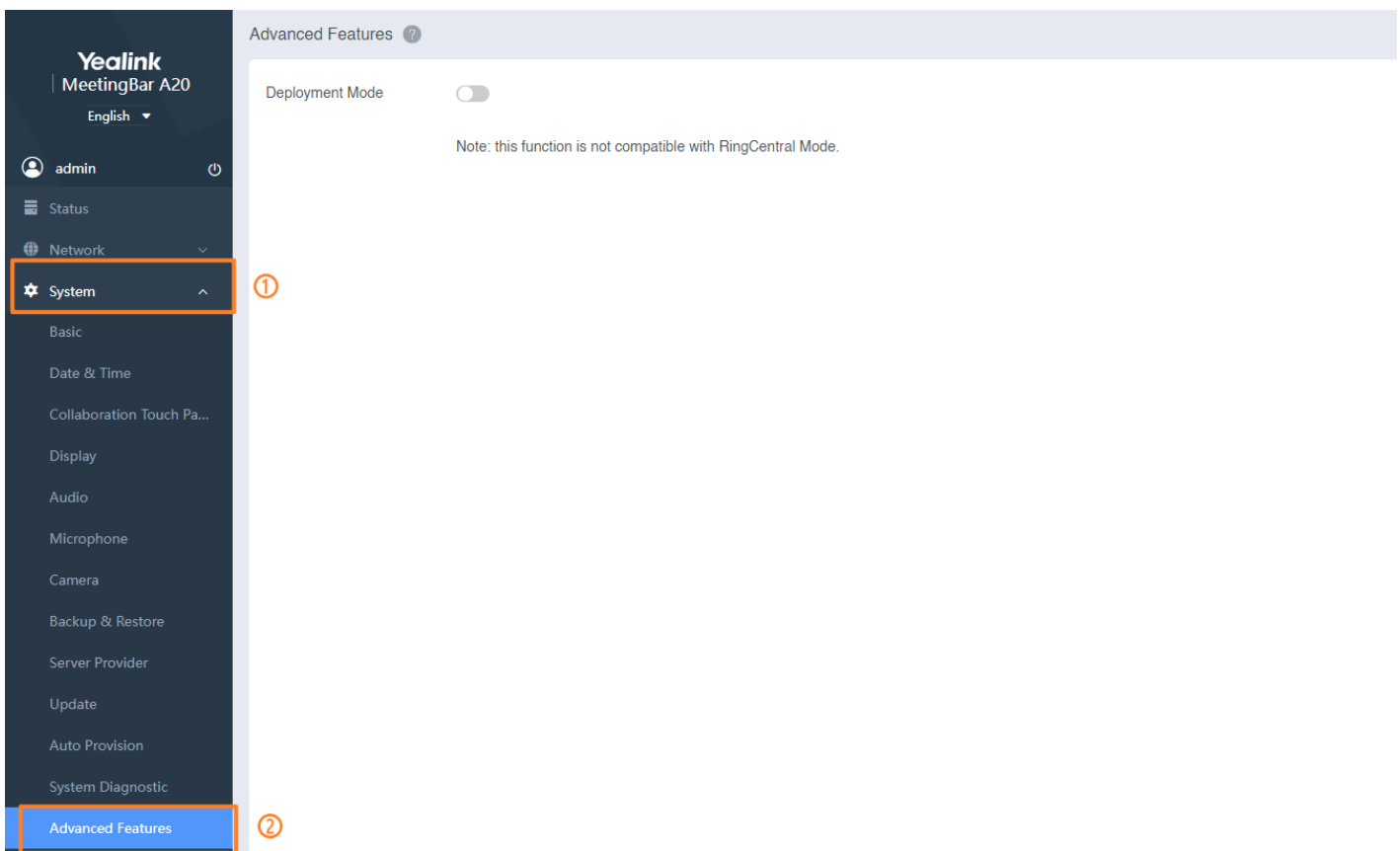
**2. Connect to CTP18****NOTE**

When using the deployment mode, the VCH port on the MeetingBar A20/A30 cannot be connected to a microphone or VCH51.

Use a network cable to connect the VC Hub/Phone port of MeetingBar A20/A30 to the network port of CTP18 respectively.

Pair CTP18 with A10/A20/A30

For more information, please refer to [Pair MeetingBar AX0 with CTP18](#).

Update CTP18

You need to update CTP18 on the web user interface of MeetingBar AX0. For more information, please refer to [Firmware Update](#).

FAQ

[Can the CTP18 be wall mounted?](#)

VCR11 Remote Control

Introduction

You can use the VCR11 Remote Control to control the MeetingBar A10/A20/A30. VCR11 uses two AAA batteries (1.5V).

VCR11 Compatibility

For the VCR11 compatibility, please refer to [Teams Room Accessories Compatibility Lists](#).

How to Use

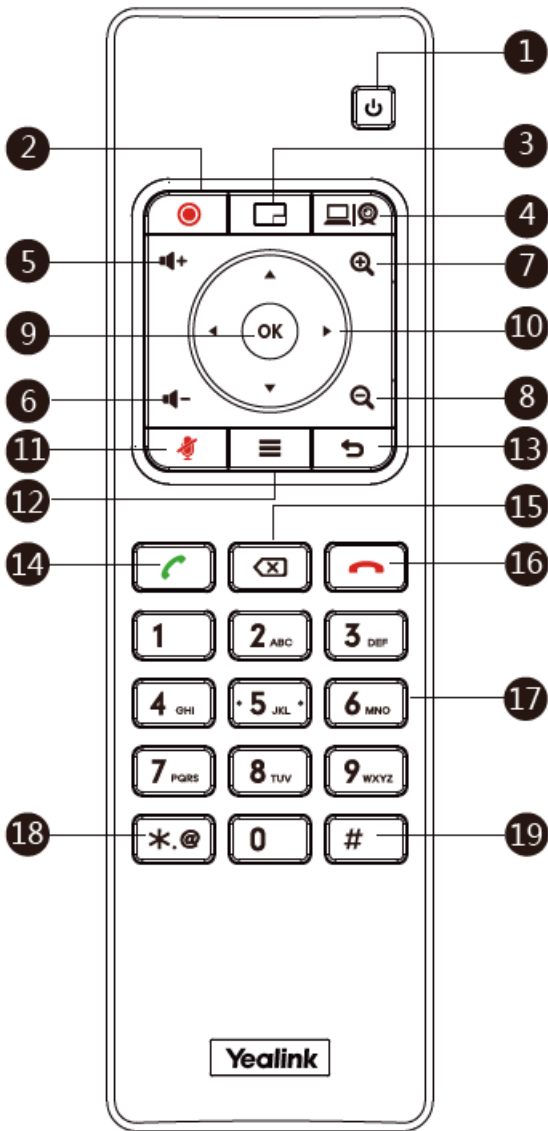

No.	Name	Description
1	Power on/off Key	Put the system to sleep mode or wake up the system.
2	Video Recording Key*	Start/stop recording the video and the audio.
3	Layout Key	<ul style="list-style-type: none"> - On the home screen, pressing the key will join the first meeting on the meeting list. - On the home screen or during a meeting, press and hold the key for 5 seconds will bring up the sidebar.
4	Custom Key*	Customizable shortcuts are available.
5	Volume up key	Increase the speaker volume.

6	Volume down key	Reduce the speaker volume.
7	Zoom in key	Zoom in the camera' s focal length.
8	Zoom out key	Zoom out the camera' s focal length.
9	OK key	Go to the sub-menu to confirm the action or select one item.
10	Navigation Key	- Navigate through menu items. - Pan and tilt the camera to adjust the viewing angle.
11	Mute Key	Mute or unmute the microphone.
12	Home key	Press and hold the button for 5 seconds to bring up the sidebar.
13	Back key	Return to the previous menu.
14	Off-hook Key	Enter the pre-dialing screen, the dialing screen or the answering screen.
15	Delete Key	Delete one character at a time. Press and hold to delete all characters in the input field.
16	On-hook Key	End a call or exit a meeting call.
17	Keypad	- Enter digits. - Go to the Dial page. - In the camera control interface, if a preset position has been set for a specific number key, pressing that number key will activate the corresponding preset position. If you press and hold the number key for 5 seconds, it will replace the corresponding preset position.
18	Character Key	Enter the special characters . * @ .
19	Pound key	Enter the pound key (#).

*Coming Soon.

FAQ

Does the VCR11 remote control support camera preset?

The VCR11 remote control supports up to 9 camera presets.

1. To add a camera preset for the first time, you need to go to **More > Settings > Device Settings > Camera > Camera Settings**.
2. Press the **OK** key on the VCR11 to select **Preset**.

3. Click **Add**. Press the 1-9 number keys of the VCR11 to apply the camera preset of the corresponding number. Press and hold for about 3 seconds to replace the camera preset with the corresponding number. For more information, please refer to [Camera Preset](#).

VCR20 Remote Control

Introduction

You can use the VCR20 Remote Control to control the MeetingBar A20/A30. VCR20 uses two AAA batteries (1.5V).

VCR20 Compatibility

For the VCR20 compatibility, please refer to [Teams Room Accessories Compatibility Lists](#).

How to Use

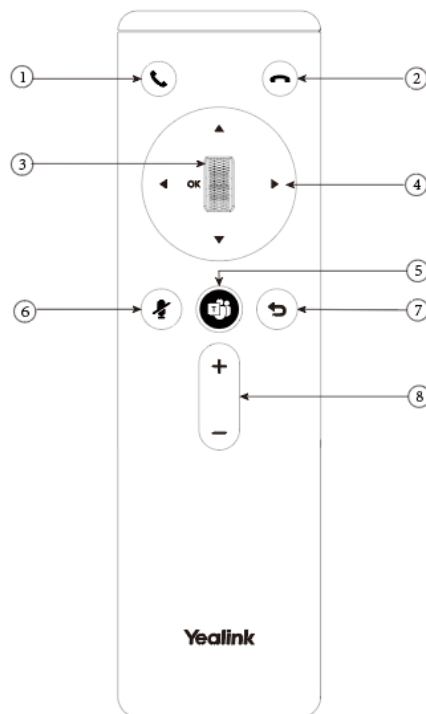

No.	Item	Description
1	Answer Key	Make or receive calls
2	End Key	End a call or exit the current meeting.
3	Scroll Wheel (OK Key)	- Swipe up to zoom in the camera image - Swipe down to zoom out the camera image - Press OK to confirm.
4	Navigation Key	Pan and tilt the camera to adjust the viewing angle.

5	Teams Key	<ul style="list-style-type: none">- On the home screen, press the Teams key to join the first meeting on the meeting list.- On the home screen or in a meeting, press and hold the Teams key for 5 seconds to open the sidebar.
6	Mute Ke	Mute or unmute the microphone.
7	Return Key	Return to the previous level.
8	Volume Key	Turn up/down the volume.

Other

Dual Monitors

Introduction

After the connection is completed, the display connected to HDMI 1 port serves as the primary screen, while the display connected to HDMI 2 port serves as the secondary screen.

We recommend that you connect at least one external display to the MeetingBar A20/A30 to enjoy the video and content sharing in the meeting fully. If you connect two external displays, the second display will display the shared content fully. The MeetingBar A10 only supports connecting one display.

How to Use

Single Display - Video Call Only

The remote video is displayed in full screen, and the local video is displayed as a thumbnail.



Single Display - Video Call with Content Sharing

The display shows a large view of the shared content and a smaller thumbnail of the local video. Only the local video is displayed, and the remote video is not displayed.

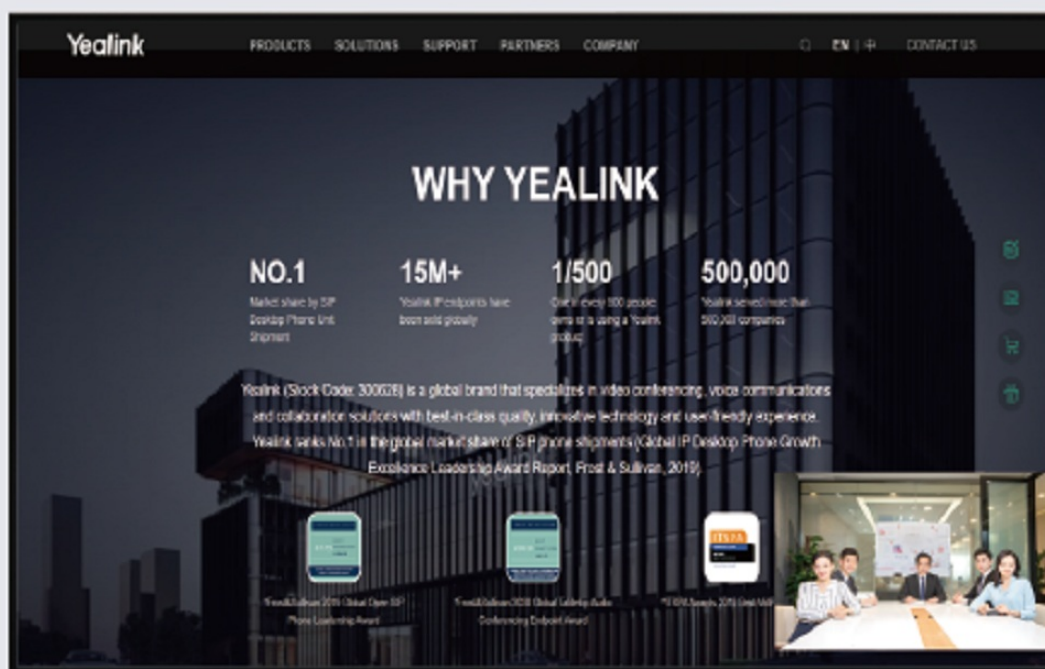

Dual Displays - Only Video Calls

After the MeetingBar A20/A30 is connected to two displays, it can automatically lay out the remote participants on the two displays during the video call.

When you meet with one participant, the video of the local and remote video screens are displayed on two displays respectively.



Remote Video Screen



Local Video Screen



When meeting with multiple participants, the window's lower-right corner displays the local video, and the remote video will be evenly displayed on the two displays.



Remote Video Screen 1



Remote Video Screen 2

Local Video Screen





Remote Video Screen 1

Remote Video Screen 3



Remote Video Screen 2

Local Video Screen



Local Video Screen



Dual Displays - Only Content Sharing

The main screen displays the Teams main page, and the secondary screen displays shared content.

Dual screen - Video Call with Whiteboard

The main screen displays local and remote video images, a large view of the remote video, and a thumbnail of the local video. The secondary screen displays a whiteboard.

Dual Displays - Video Call with Content Sharing

The main screen displays local and remote video images, a large view of the remote video, and a thumbnail of the local video. The secondary screen displays shared content.



FAQ

It prompts “this feature is only available on the Pro plan” ?

Reboot & Sleep & Shut Down

Introduction

You can quickly restart/sleep/shut down the MeetingBar A10/A20/A30.

How to Use

Reboot

Go to  > **Settings** > **General** > **Reboot**. When CTP18 and AX0 are successfully paired, both AX0 and CTP18 will restart if you tap **Reboot** on CTP18.

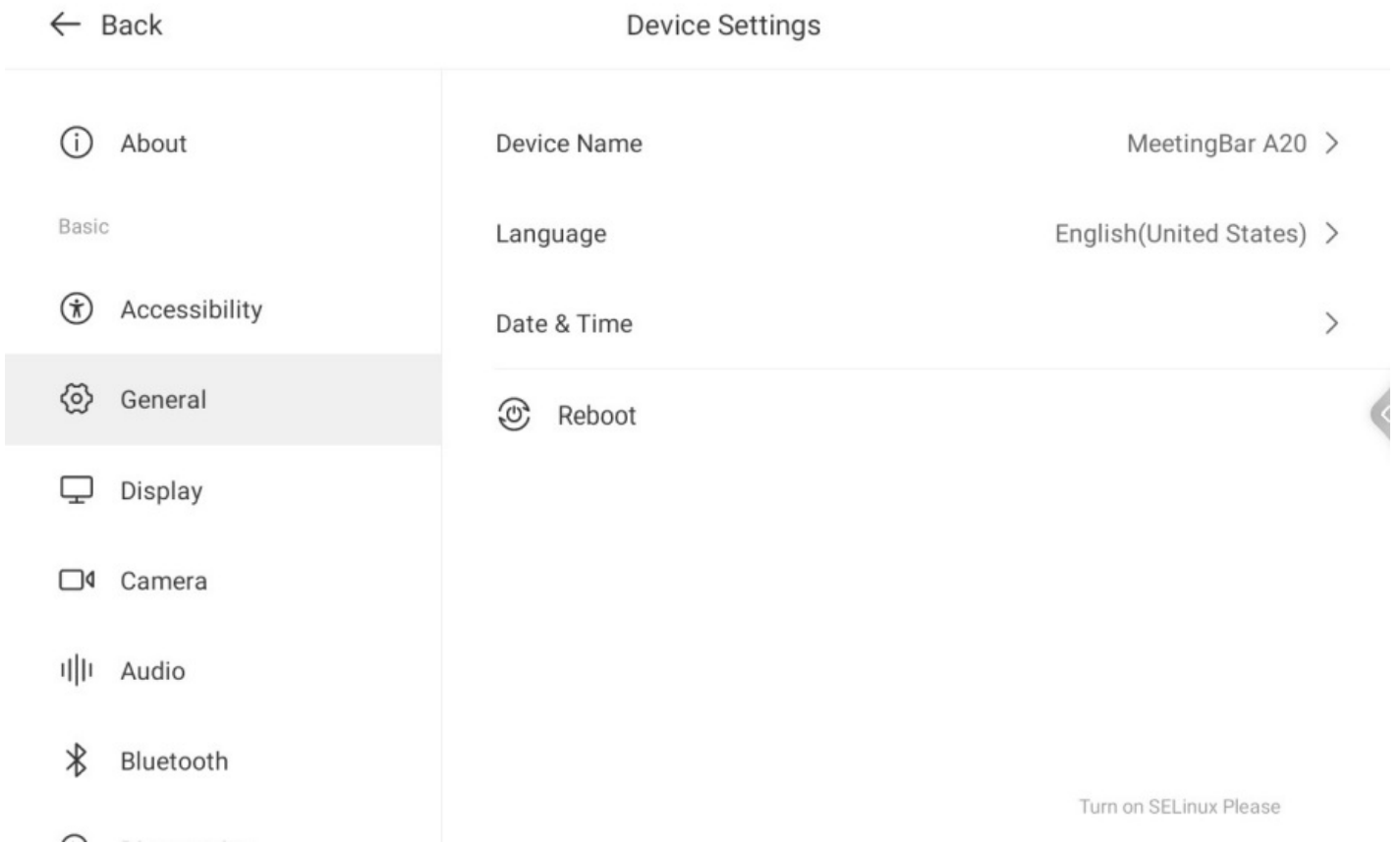

Sleep

Automatic Sleep

You can configure the MeetingBar AX0 to wake the screen automatically and enter the sleep times automatically. For more information, please refer to [Display Settings](#).

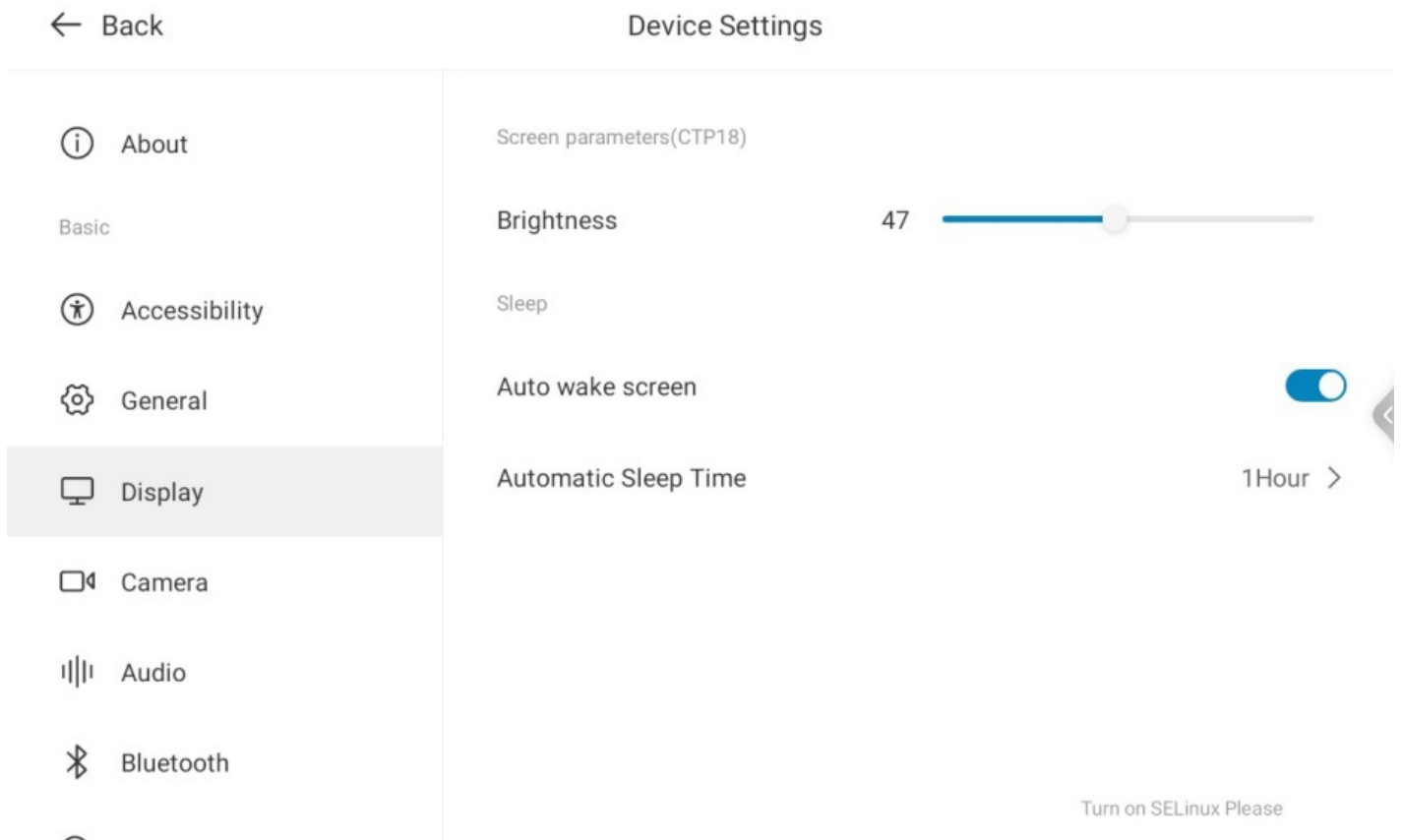

Manual Sleep

NOTE

MeetingBar A10 is supported by version 278.321.0.20 and later but not by MeetingBar A20 and MeetingBar A30.

After disabling **auto wake screen** (go to **Settings > Display**), you can use the remote control to put the MeetingBar A10 to sleep.

Press the remote control **Power** key and select **Sleep**.

Tap CTP18 or press any key on the remote control to wake the MeetingBar A10.

Shut Down

NOTE

- The MeetingBar A10 versions 278.321.0.20 and later support shutdown via remote control, but MeetingBar A20 and MeetingBar A30 do not.
- The CTP18 does not have a power on/off option. It can be powered on by plugging in the power supply and powered off by unplugging the power supply.

Press the remote control **Power** key and select **Shut down**, then press **OK** in the pop-up window to shut down. The MeetingBar A10 goes into a shutdown state, and the CTP18 will disconnect from the A10, and the screen will remain on. Press the remote control **Power** key again, and the MeetingBar A10 will boot up and automatically re-pair with the CTP18.

Electric Privacy Shutter

Introduction

The electric privacy shutter of MeetingBar A10/A20/A30 (hereafter referred to as MeetingBar AX0) protects the user's privacy in the meeting room.

How to Use

The camera cover opens automatically when you join a meeting and closes automatically when you leave the meeting.



CEC

Introduction

The CEC support of MeetingBar A10/A20/A30 (hereinafter referred to as MeetingBar AX0) synchronizes the standby and wake-up status with CTP18/TV.

Before You Begin

The TV connected to MeetingBar AX0 supports and enables CEC functionality.

How to Use

CEC is enabled by default on MeetingBar AX0. Please refer to [Display Settings](#) to disable this configuration.

NOTE

You can enable and disable automatic wake up, please refer: [Sleep](#).



FAQ

[How to turn off the TV when A10/A20/A30 is connected to the TV? \(CEC\)](#)

[Which third-party TVs can use the CEC function with A10/A20/A30?](#)

Calling

Introduction

MeetingBar A10/A20/A30 (hereinafter referred to as MeetingBar AX0) can make a call by dialing a number. When you call someone, you can only call the callee with audio. And the callee can choose an audio answer or a video answer.

You can call multiple people via video but cannot use the meeting whiteboard.

Before You Start

You need to log in to your Microsoft Teams account in MeetingBar AX0.

Use via Remote Control

NOTE

If you have configured a calling plan for your Teams account, you can join a meeting by dialing a phone number.

Select **Call** and enter the number to dial out.

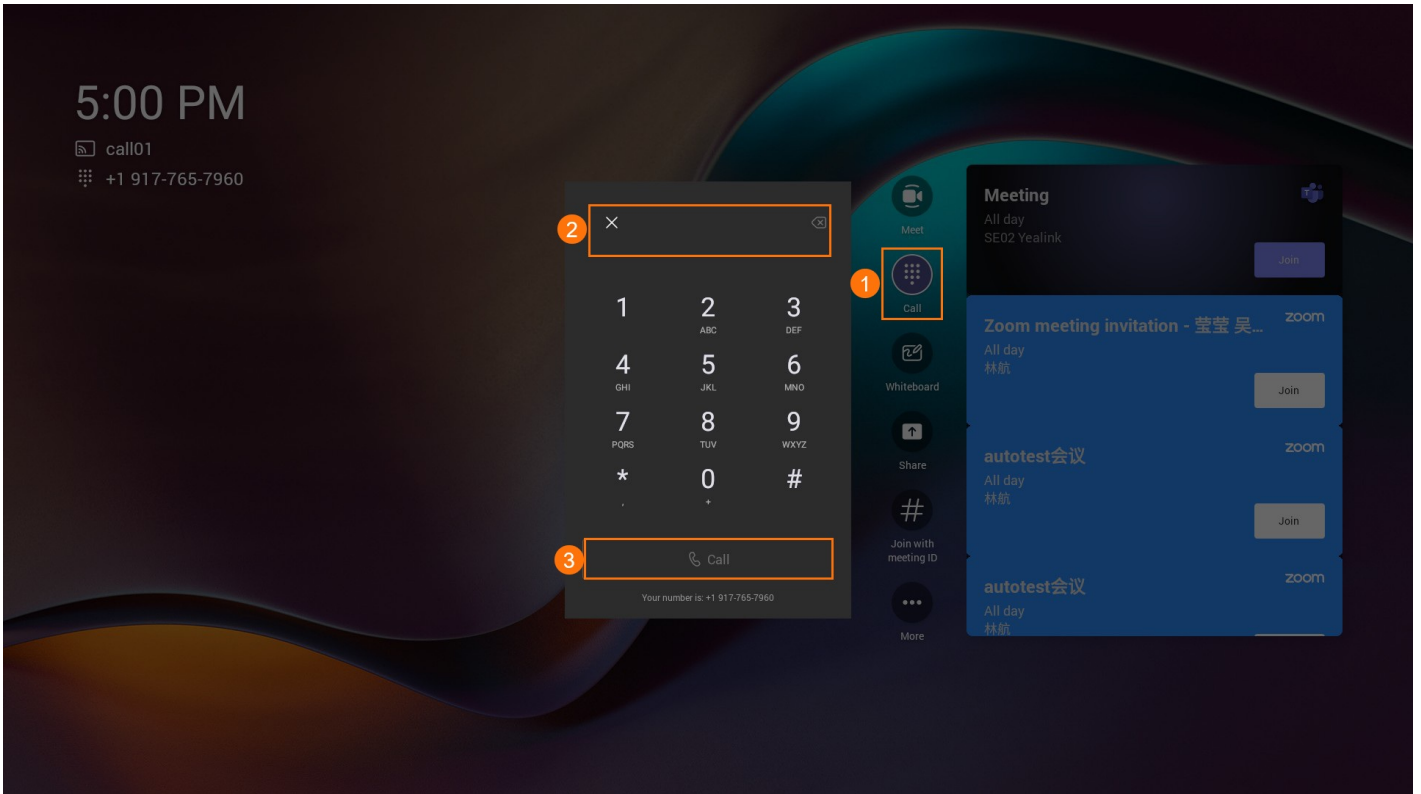
**Use via CTP18 Control****NOTE**

If you have configured a calling plan for your Teams account, you can join a meeting by dialing a phone number.

Tap **Call** and enter the number to dial out.

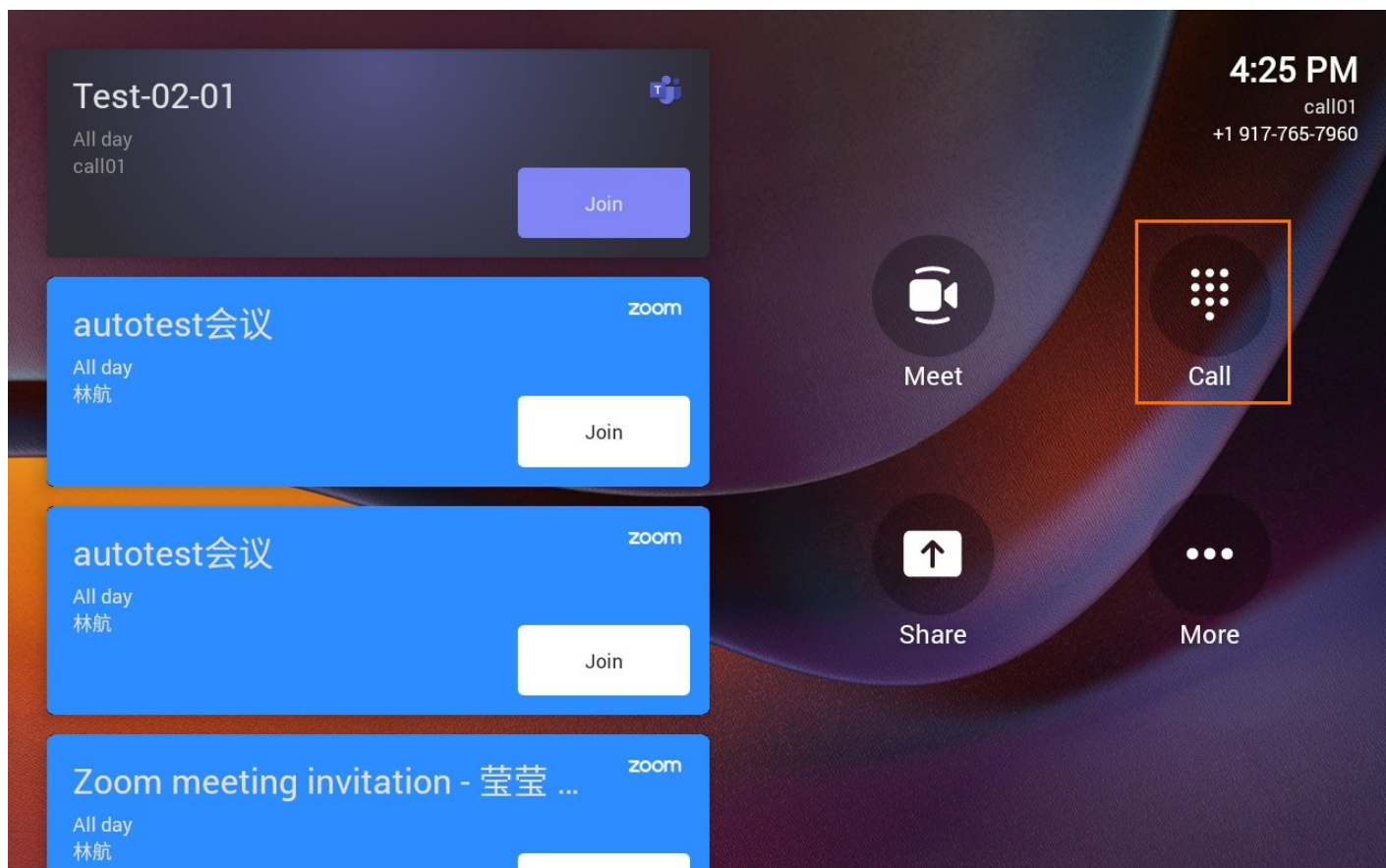

FAQ

How do I get my number if the calling function has been configured for my Teams account?

The phone number of the Teams account is displayed in the upper-left corner.
As shown in the figure, the number of user call01 is 19XXXXXXXX60.



Lens Calibration

Introduction

Suppose the image output by the lens of MeetingBar A30 does not meet the expected effect during the tracking. In that case, you can perform lens calibration (for example, the tracking speed becomes slow, the participant image is not centered, etc.).

For the operation video, please refer to [Lens Calibration](#).

How to Use

NOTE

When you calibrate the lens, please make sure that there are no other things within 3 meters in front of the lens.

1. On the CTP18 or with the remote control, go to **More > Settings > Device Settings > Diagnostics > Camera Calibration**.
2. Select **Start Calibration**.

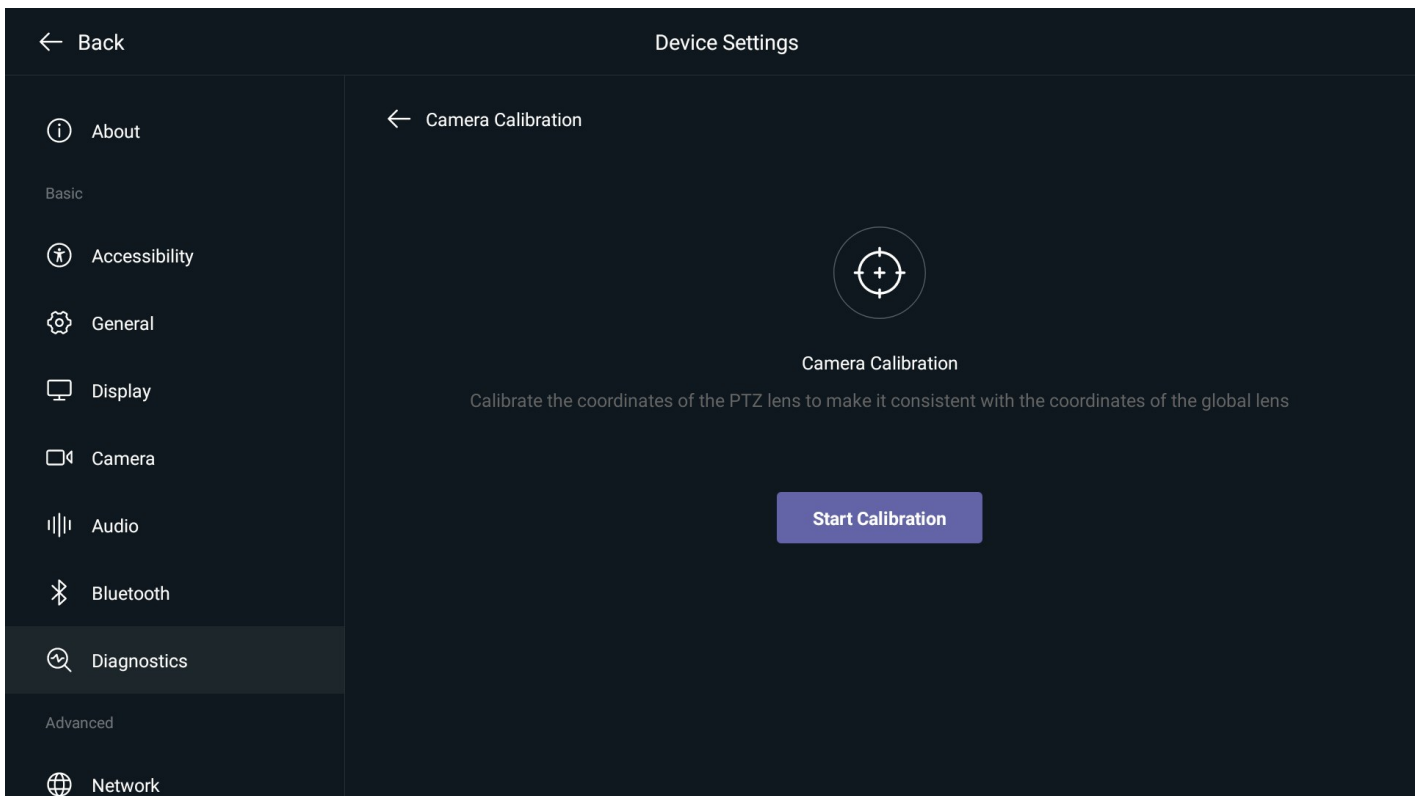

Dual Touch Display

Introduction

MeetingBar A20/A30 supports dual-screen touch. When you use the whiteboard to share content, you can connect two touch displays for operation. When the MeetingBar A20/A30 is connected to two touch displays, both displays can be touched correctly. MeetingBar A20/A30 is connected to two displays, and only one is a touch display; the primary and secondary displays can be touch operated.

How to Use

1. Connect a USB cable to the MeetingBar A20/A30 and touch display.
2. Select one of the HDMI screens as the touch display. If you only need a touch display, you can skip step 3.
3. Plug another USB data cable to connect the MeetingBar A20/A30 and another touch display.